

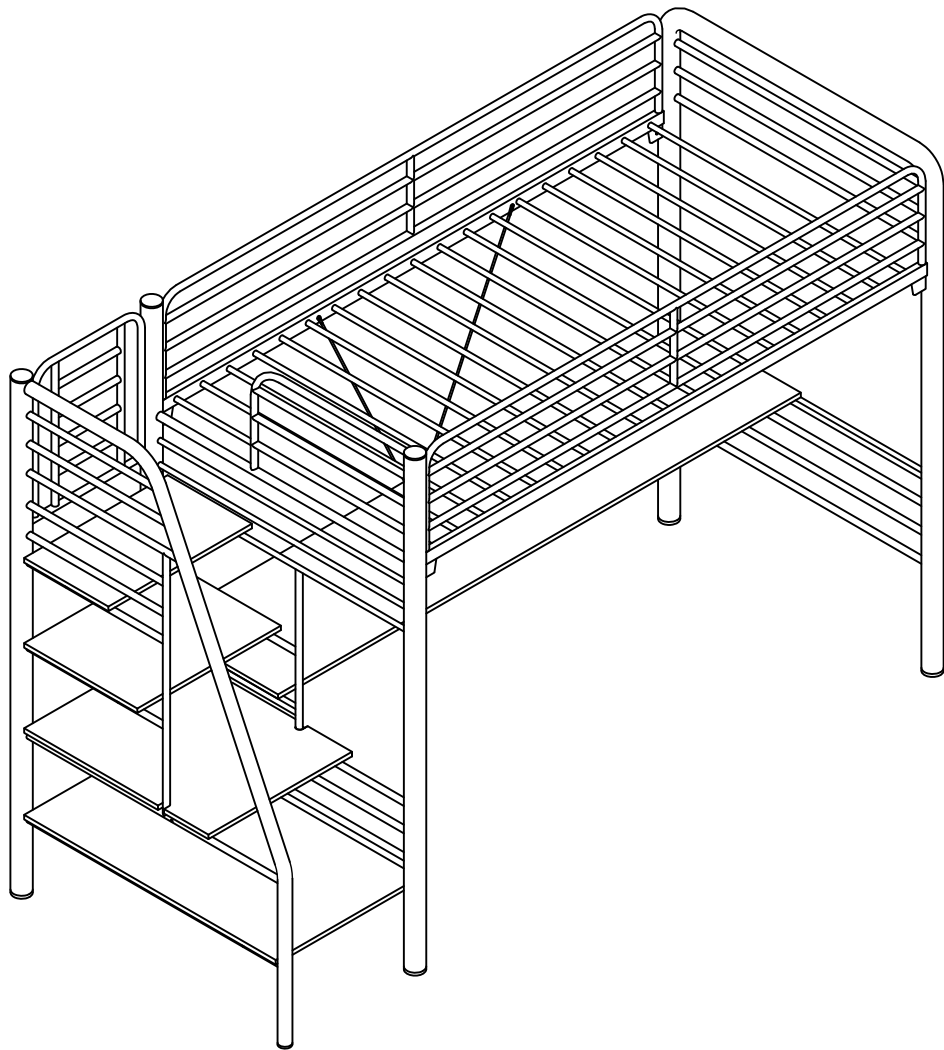

**Fort Worth, Texas**



# ASSEMBLY INSTRUCTIONS

MODEL: 4504-5

NOTE: THIS ITEM NOT RECOMMENDED FOR COMMERCIAL USE  
KEEP THIS DOCUMENT FOR REFERENCE IN CASE PARTS ARE NEEDED  
DO NOT TIGHTEN SCREWS UNTIL COMPLETELY ASSEMBLED!!

## **Size of Mattress**

This bed is designed to use a mattress 74"x37<sup>1/2</sup>"-39" on the upper bunk and the lower bunk. The thickness of the mattress must not exceed 9" on the upper bunk. There must be at least 5" from mattress sleeping surface to top edge of guard rail on the upper bunk.

## **Replacement Parts**

Replacement parts, including additional guardrails, may be obtained from any of our retail dealers.



## **Additional Note**

Maximum total weight not to exceed 150 lbs. on the upper bunk, and maximum 200 lbs. On the lower bunk.



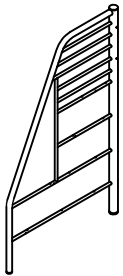
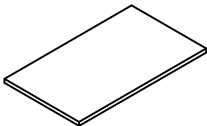
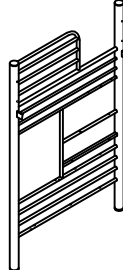
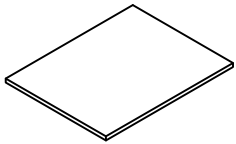
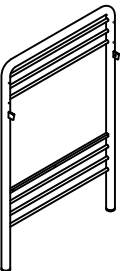
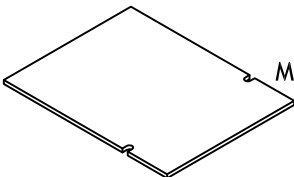
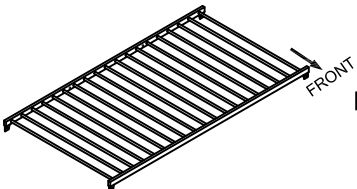
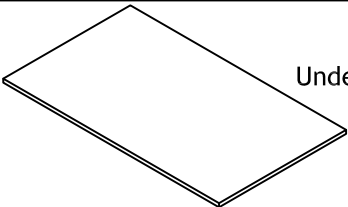
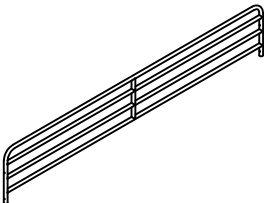
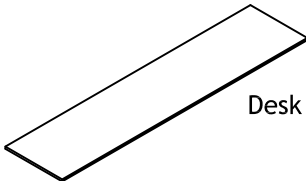
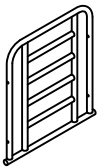
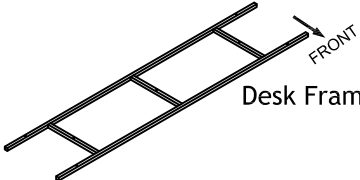

## **SAFETY WARNINGS**

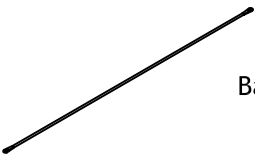
1. Follow the information on the warnings appearing on the upper bunk end structure and on the carton. Do not remove warning label from bed.
2. Always use the recommended size mattress or mattress support, or both, to help prevent the likelihood of entrapment or falls.
3. Surface of mattress must be at least 5 inches (127mm) below the upper edge of guardrails.
4. Do not allow children under 6 years of age to use the upper bunk.
5. Periodically check and ensure that the guardrail, ladder, and other components are in their proper position, free from damage, and that all connectors are tight.
6. Do not allow horseplay on or under the bed and prohibit jumping on the bed.
7. Always use the ladder for entering and leaving upper bunk.
8. Do not use substitute parts. Contact the manufacturer or dealer for replacement parts.
9. Use of a night light may provide added safety precaution for a child using the upper bunk.
10. Always use guardrails on both long sides of the upper bunk. If the bunk bed will be placed next to a wall, the guardrail that runs the full length of the bed should be placed against the wall to prevent entrapment between the bed and the wall.
11. The use of water or sleep flotation mattresses is prohibited.
12. Strangulation Hazard- Never attach or hang items to any part of the bunk bed that are not designed for use with the bed; for example, but not limited to . hooks, belts and jump ropes.
13. Keep these instructions for future reference.
14. Prohibit more than one person on upper bunk.
15. Adult assembly required due to the presence of small parts, sharp points, sharp edges as recessed.

## BED PARTS

NO	DESCRIPTION	QTY	NO	DESCRIPTION	QTY
①	 Left Side frame	1 PC	⑧	 Step Shelf	1 PC
②	 Middle frame	1 PC	⑨	 Top Step Shelf	1 PC
③	 Right side frame	1 PC	⑩	 Middle Step Shelf	1 PC
④	 Bed Stead	1 PC	⑪	 Underside Step Shelf	1 PC
⑤	 Guardrails	2 PCS	⑫	 Desk Top Panel	1 PC
⑥	 Back Guardrails	1 PC	⑬	 Desk Frame	1 PC
⑦	 Shelf Support Crossbar	4 PCS	⑭	 Back Tension Bar	2 PCS

## HARDWARE PARTS

NO	DESCRIPTION	QTY	NO	DESCRIPTION	QTY
A	 6x6x10mm Allen Bolt (AB6610S)	4 PCS	D	 Machine screw(M4x10MM)	4 PCS
B	 6x35x10mm Allen Bolt (AB63510S)	24 PCS	E	 Allen Wrench	1 PC
C	 Wood screw(M4x32MM)	27 PCS			

STEP 1

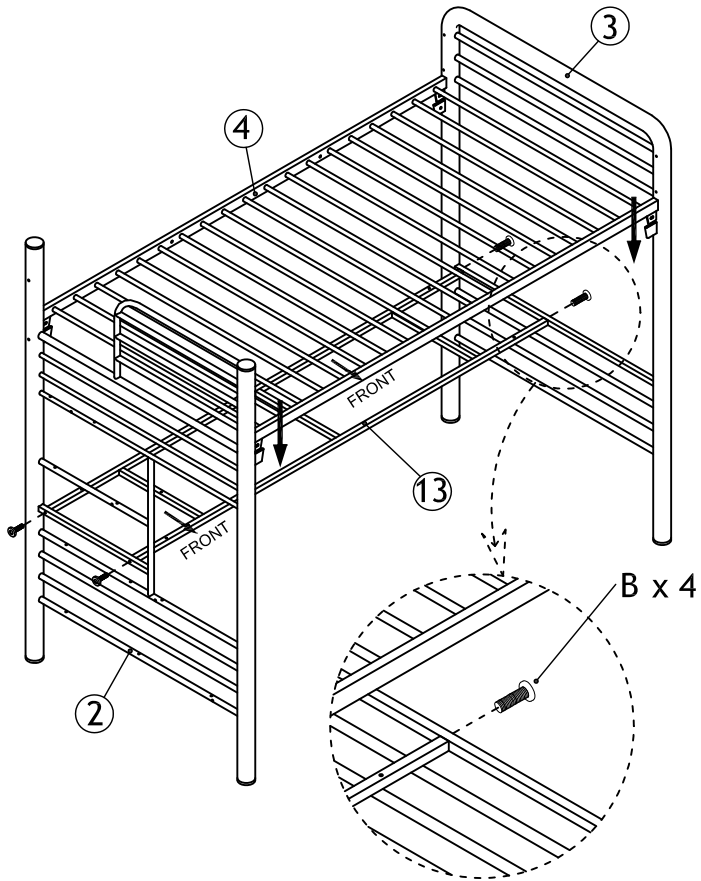

STEP 2

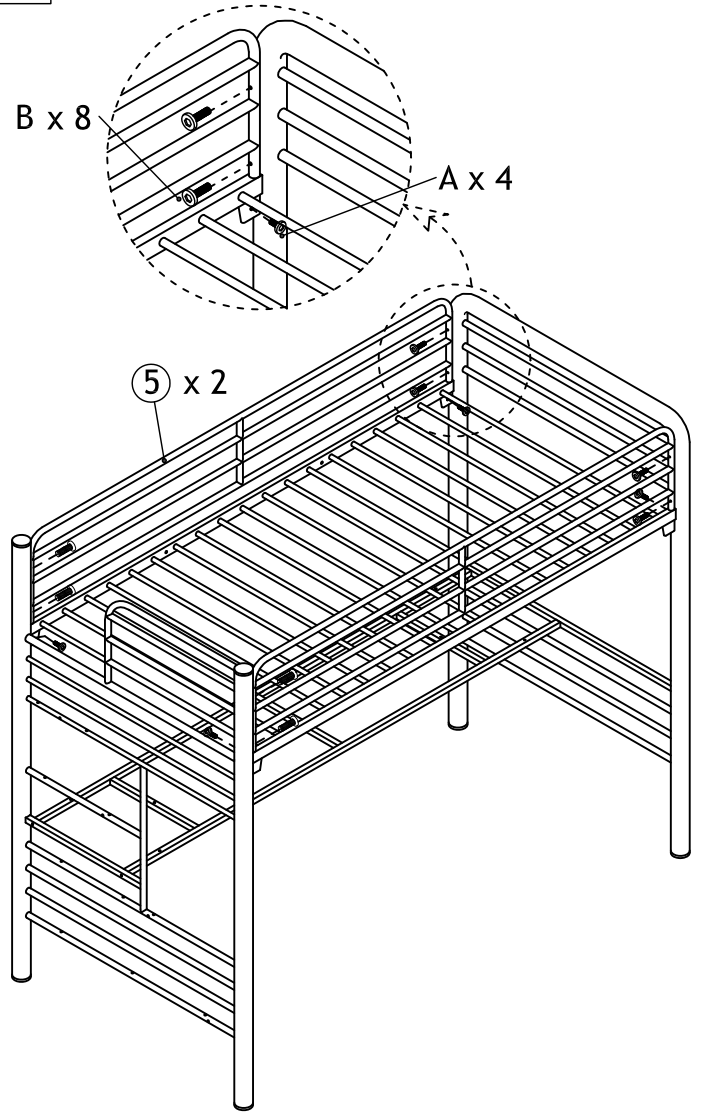

STEP 3

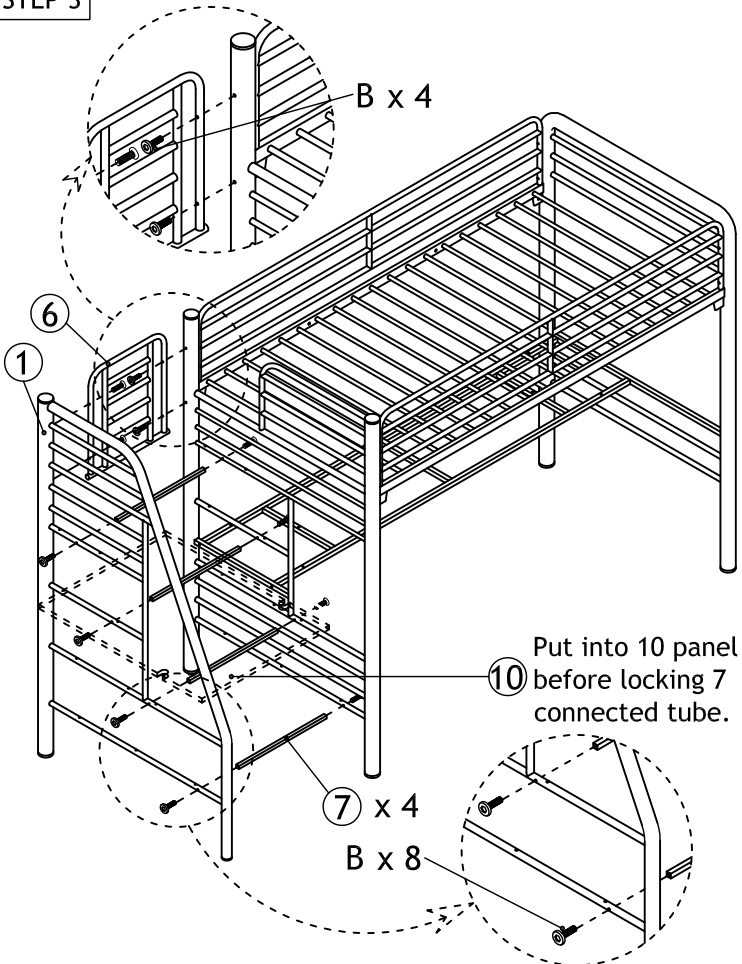

STEP 4

