

#4501-3B T/T BUNK BED

ASSEMBLY INSTRUCTION



4501-3B T/T Bunk Bed

SAFETY WARNINGS

1. Follow the information on the warnings appearing on the upper bunk end structure and on the carton.
Do not remove warning label from bed.
2. Always use the recommended size mattress or mattress support, or both, to help prevent the likelihood of entrapment or falls.
3. Surface of mattress must be at least 5 inches (127mm) below the upper edge of guardrails.
4. Do not allow children under 6 years of age to use the upper bunk.
5. Prohibit more than one person on the upper bunk
6. Periodicall, check and ensure that the guardrail, ladder, and other components are in their proper position, free from damage, and that all connectors are tight.
7. Do not allow horseplay on or under the bed and prohibit jumping on the bed.
8. Always use the ladder for entering and leaving the upper bunk.
9. Do not use substitute parts. Contact the manufacturer or dealer for replacement parts.
10. Use of a nightlight may provide added safety precaution for a child using the upper bunk.
11. Always use guardrail on both long sides of the upper bunk. If bunk bed will be placed next to the wall, the guardrail that runs the full length of the bed should be place against the wall to prevent entrapment between the bed and wall.
12. The use of water or sleep flotation mattresses is prohibited.
13. Keep these instruction for future reference.

STRANGULATION HAZARD - Never attach or hang items to any part of the bunk bed that are not designed for use with the bed ; for example, but not limited to, hooks, belts and jump ropes.

SIZE OF MATTRESS AND FOUNDATION

Use only mattress, foundation and deck combined which is 74-75 inches long and 37½ - 38½ inches wide on upper bunk

Ensure thickness of mattress and foundation combined does not exceed 6 inch and mattress and is at least 5 inches below upper edge of guardrails, and lower bunk foundation

Replacement parts, maybe be obtained directly from us at the below address.

INNOVATIONS

HARDFORD,CT 06145

PARTS IDENTIFICATION

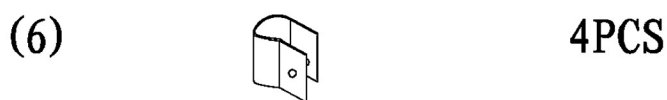
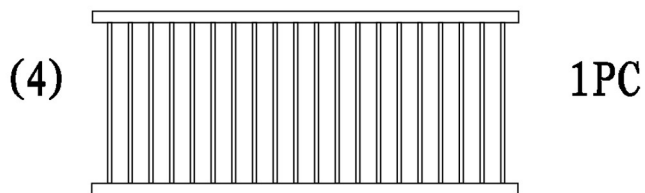
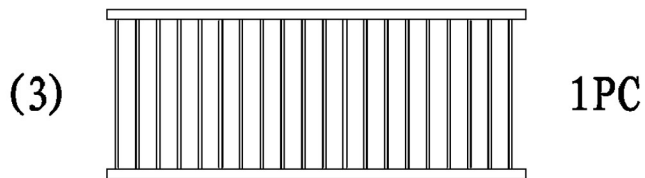
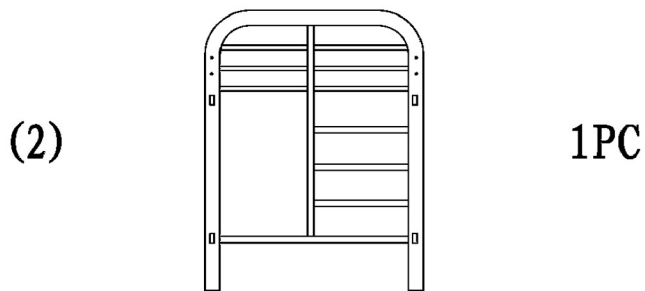
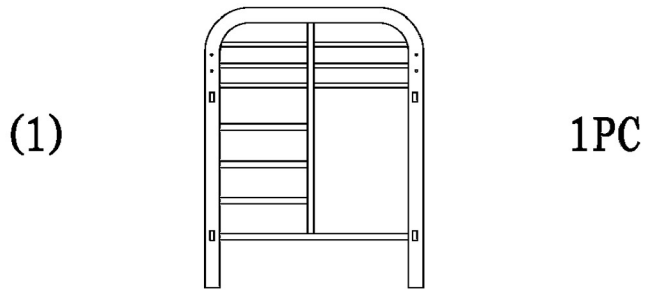

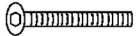
(A)  5/16" × 85mm 8PCS

(B)  5/16" × 40mm 4PCS

(C)  1/4" × 12mm 8PCS

(D)  NUT 5/16" 12PCS

(E)  SPECIAL WASHER 8PCS

(F)  WASHER 4PCS

(G)  5MM WRENCH 1PC

(H)  4MM WRENCH 1PC

(I)  WRENCH 1PC

STEP 1.

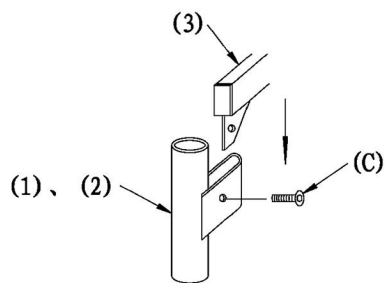
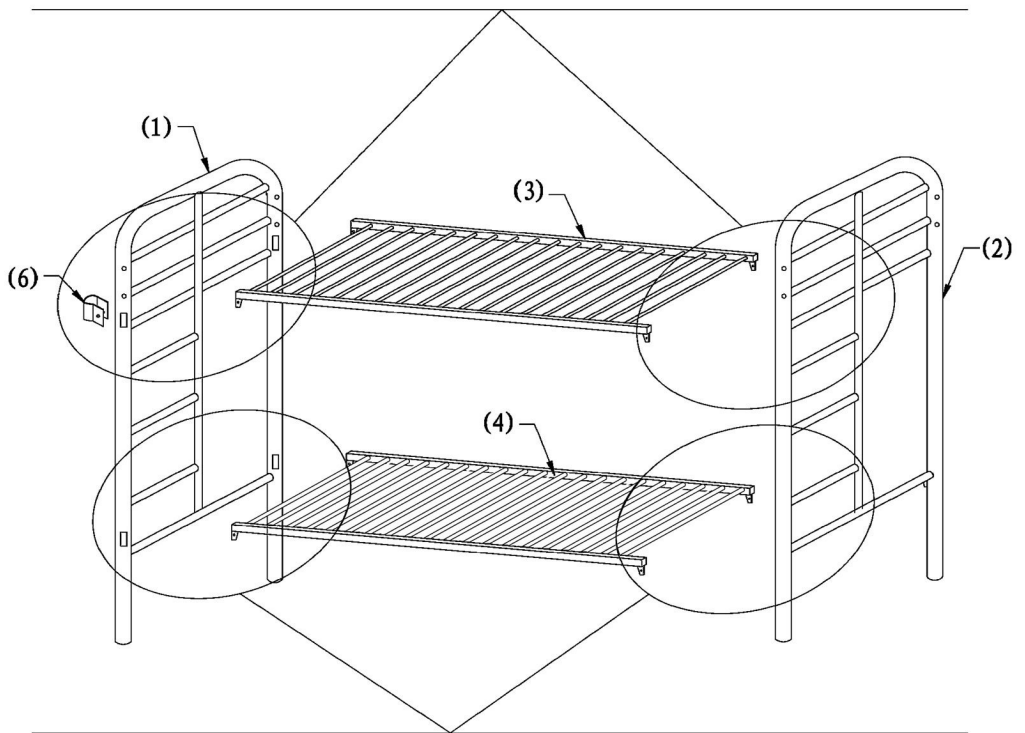
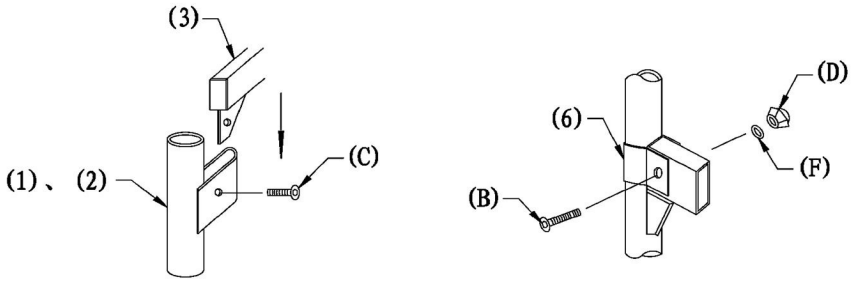

STEP 2.

