

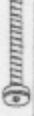







ASSEMBLY INSTRUCTION

TWIN SLEIGH CAPTAIN BED

HARDWARE LIST

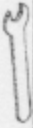
N.O	Qty	Description	Picture
A	12	Allen bolt Ø6 x L.70mm	
B	12	Barrel Nut	
C	16	Wood Dowel Ø10 x 40	
D	8	Screw Ø4 x 20	
E	8	Bolt Ø6 x L.70mm	
F	8	Half moon Ø6	
G	8	Hex nut Ø6	
H	1	Open end Wrench	
I	1	Allen key M4	

PART LIST

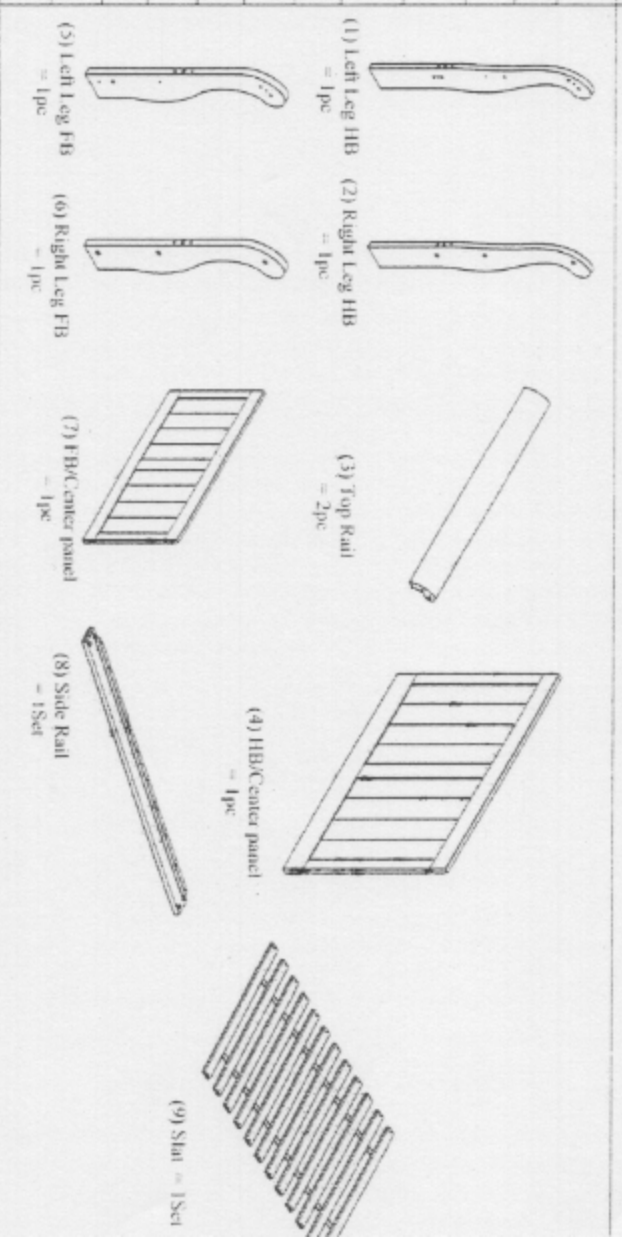

(1) Left Leg HB = 1pc

(2) Right Leg HB = 1pc

(3) Top Rail = 2pc

(4) HB/Center panel = 1pc

(5) Left Leg FB = 1pc

(6) Right Leg FB = 1pc

(7) HB/Center panel = 1pc

(8) Side Rail = 1pc

(9) Slat = 1Set

STEP 1

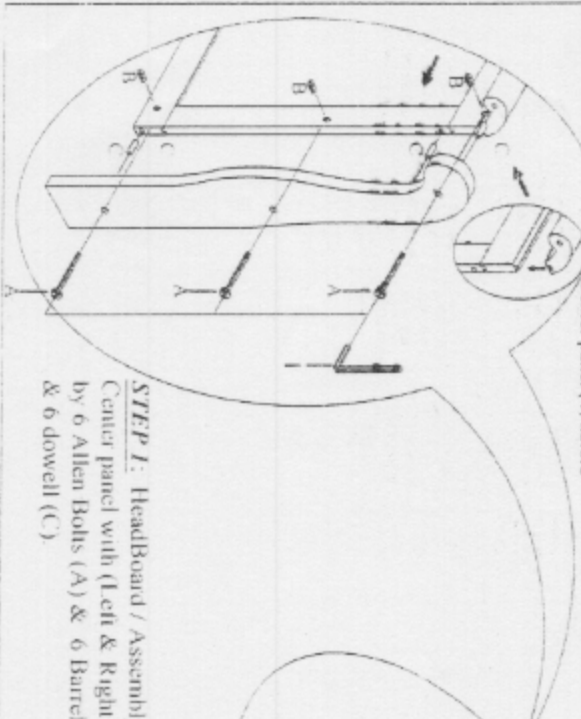

STEP 2

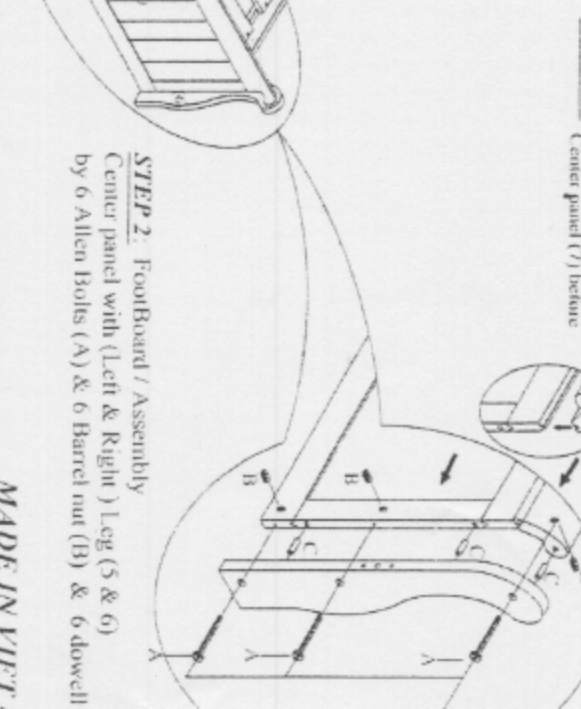

STEP 1: HeadBoard / Assembly Center panel with (Left & Right) Leg (1 & 2) by 6 Allen Bolts (A) & 6 Barrel nut (B) & 6 dowell (C)

STEP 2: FootBoard / Assembly Center panel with (Left & Right) Leg (5 & 6) by 6 Allen Bolts (A) & 6 Barrel nut (B) & 6 dowell (C)

ASSEMBLY INSTRUCTION

TWIN SLEIGH CAPTAIN BED

STEP 4

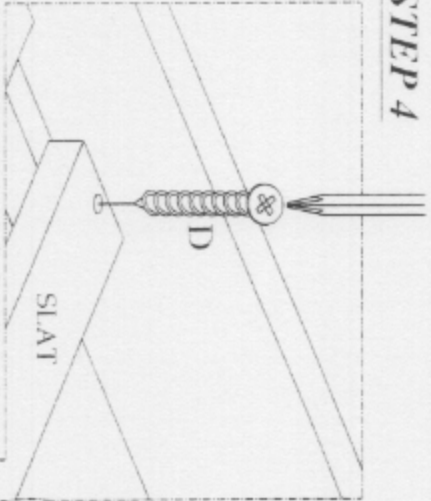

STEP 3
Slat (9) assembly with Side Rail
by 8 Screw (D).
The assembly is now complete.

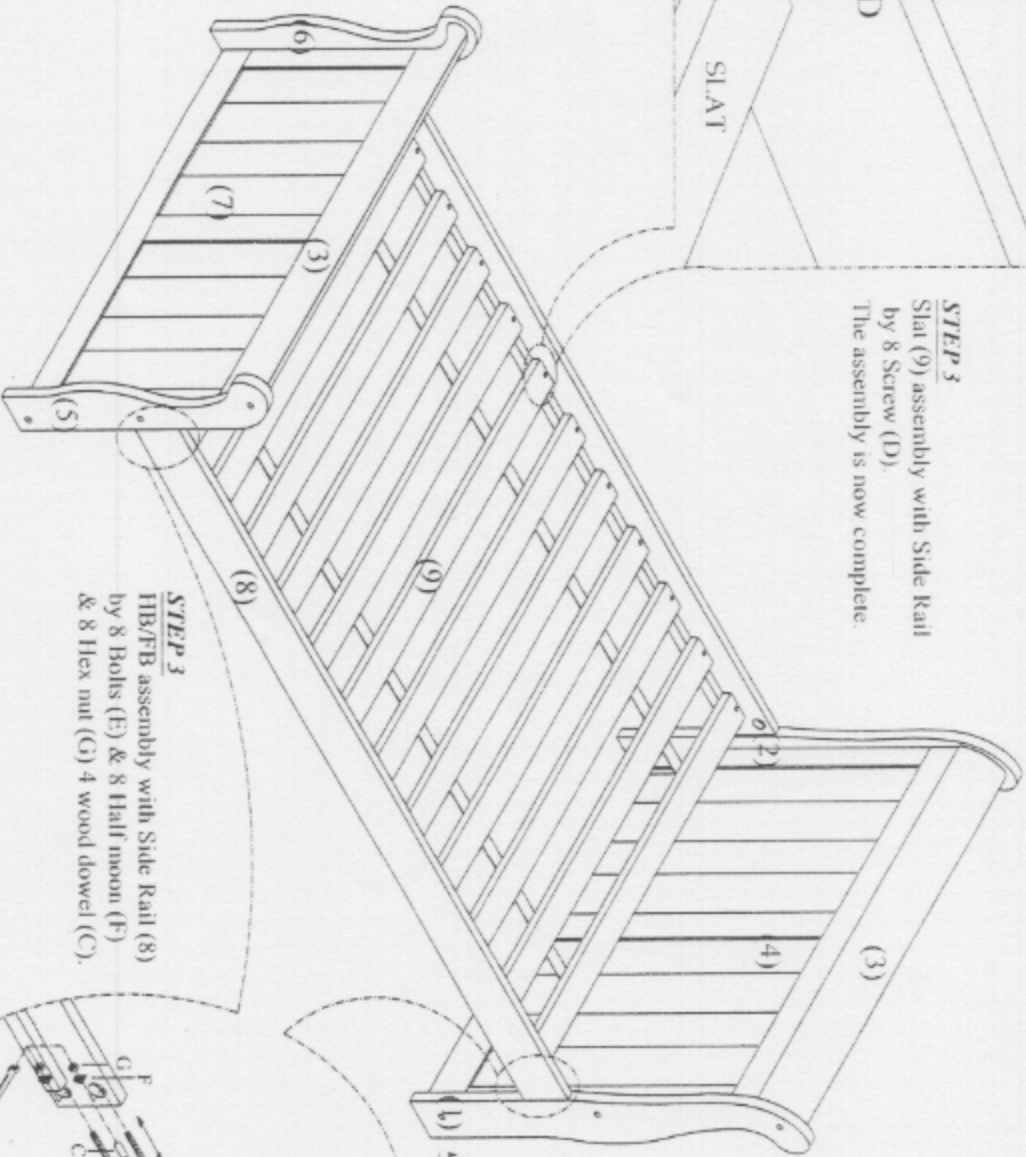





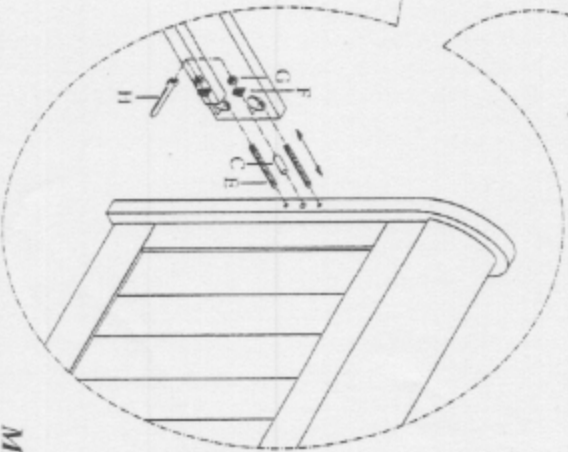

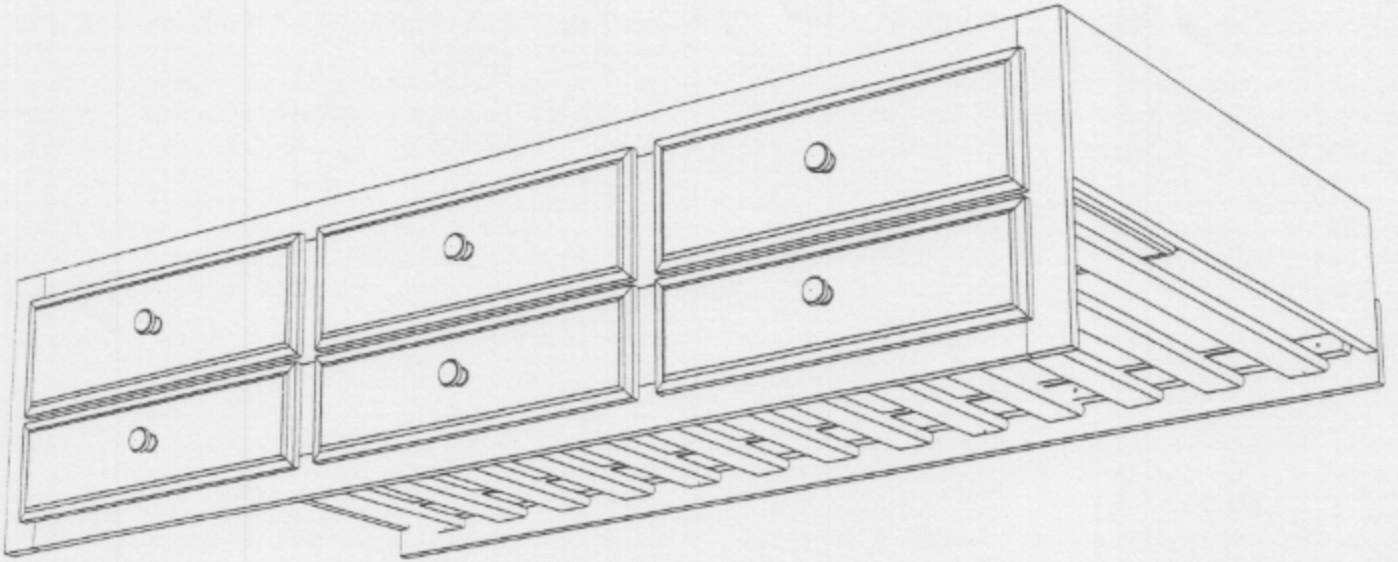
STEP 3
HB/FB assembly with Side Rail (8)
by 8 Bolts (E) & 8 Half moon (F)
& 8 Hex nut (G) 4 wood dowel (C).

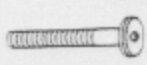
STEP 3



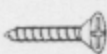
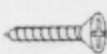

<p>B</p> <p>Ø8 x 30mm</p> <p>Qty: 18</p> 	<p>A</p> <p>Ø6 x 40mm</p> <p>Qty: 7</p> 
<p>E</p> <p>Qty: 06</p> 	<p>C</p> <p>Ø4 x 30mm</p> <p>Qty: 23</p> 
<p>G</p> <p>Qty: 04</p> 	<p>F</p> <p>Ø8 x 20mm</p> <p>Qty: 06</p> 
<p>I</p> <p>Ø10 x 40mm</p> <p>Qty: 4</p> 	<p>H</p> <p>Ø3x15mm</p> <p>Qty: 16</p> 
<p>M</p> <p>Ø4x20mm</p> <p>Qty: 18</p> 	

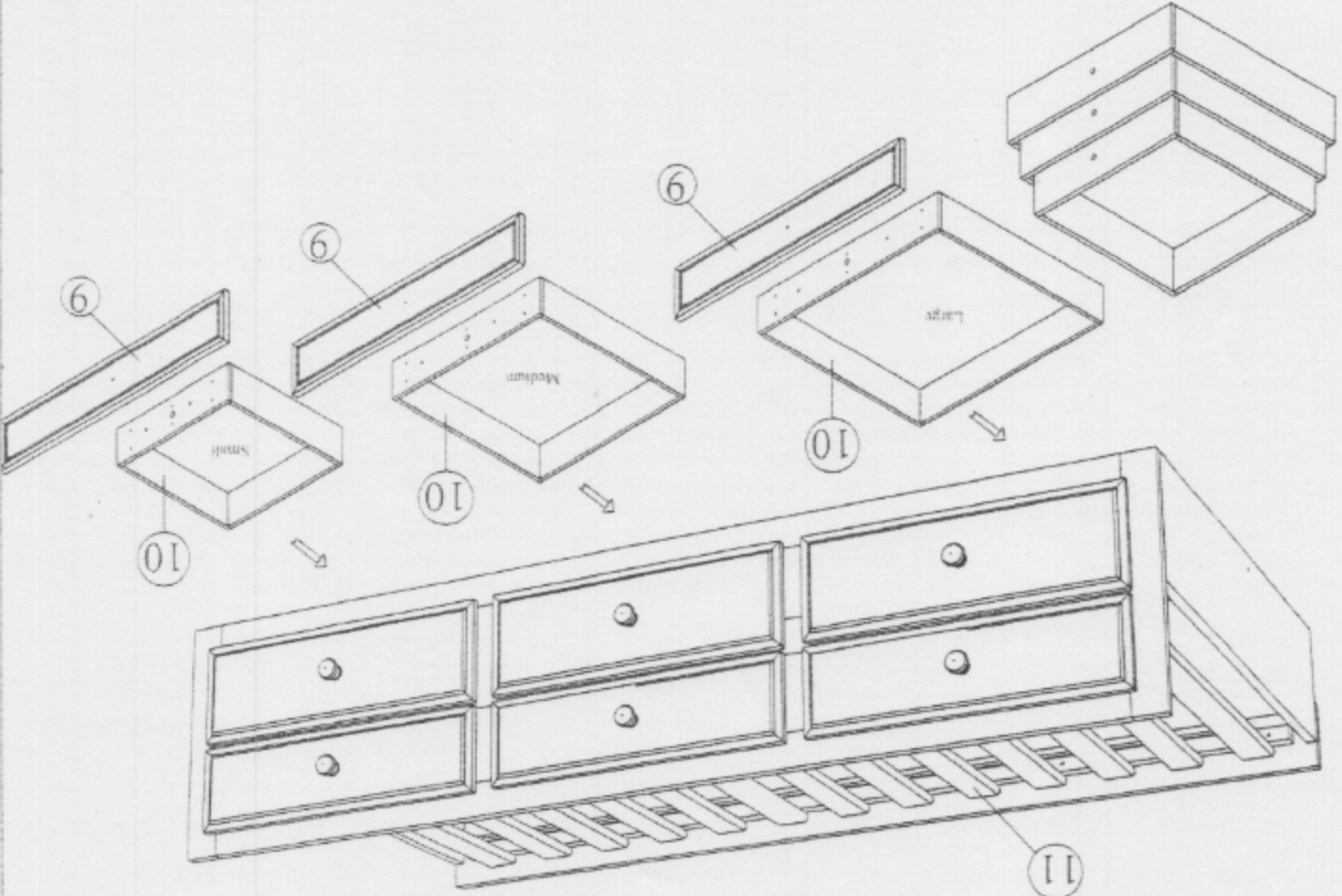

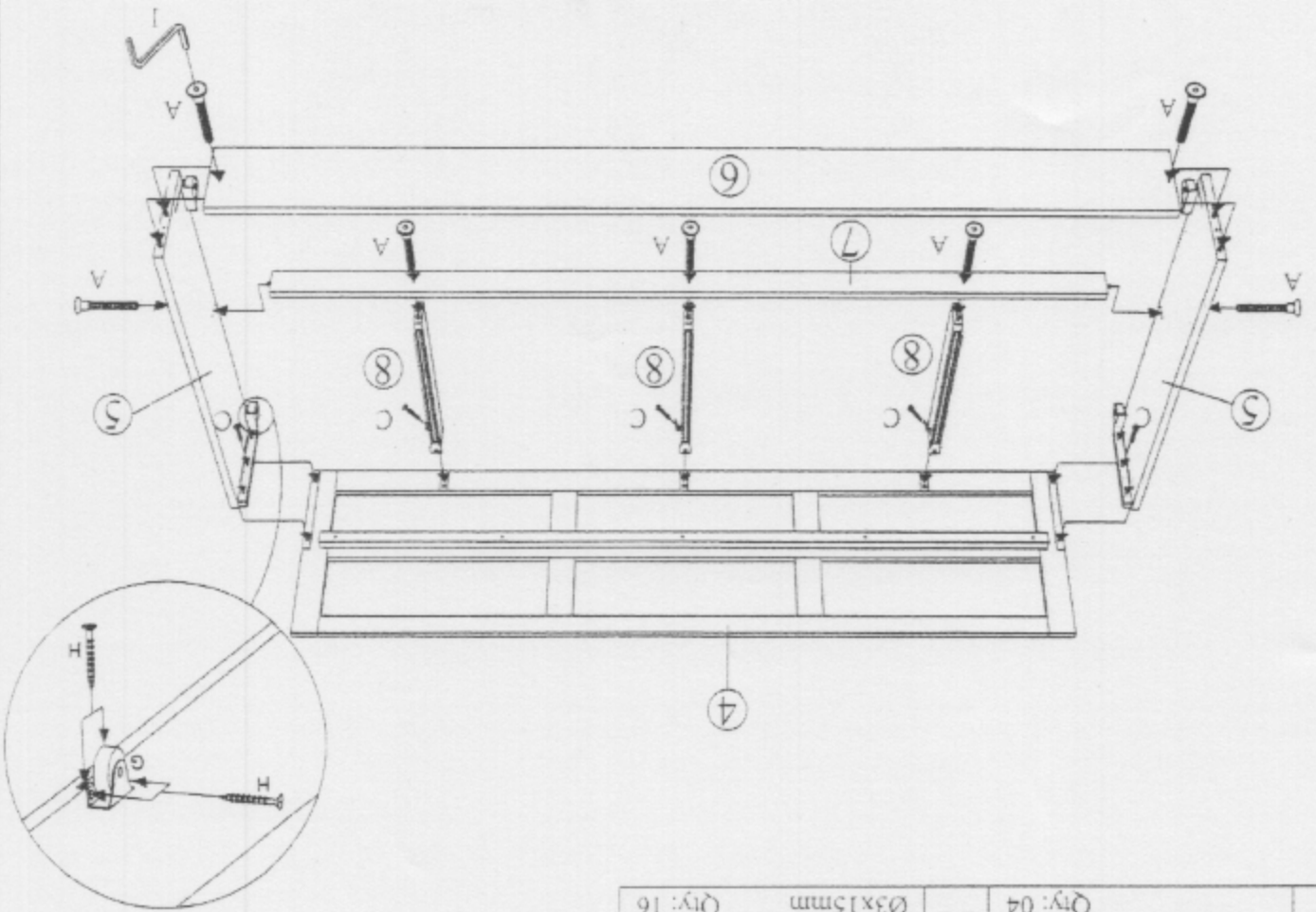

G		Qty: 04	H		Qty: 16
A		Qty: 7	C		Qty: 5
			I		Qty: 01

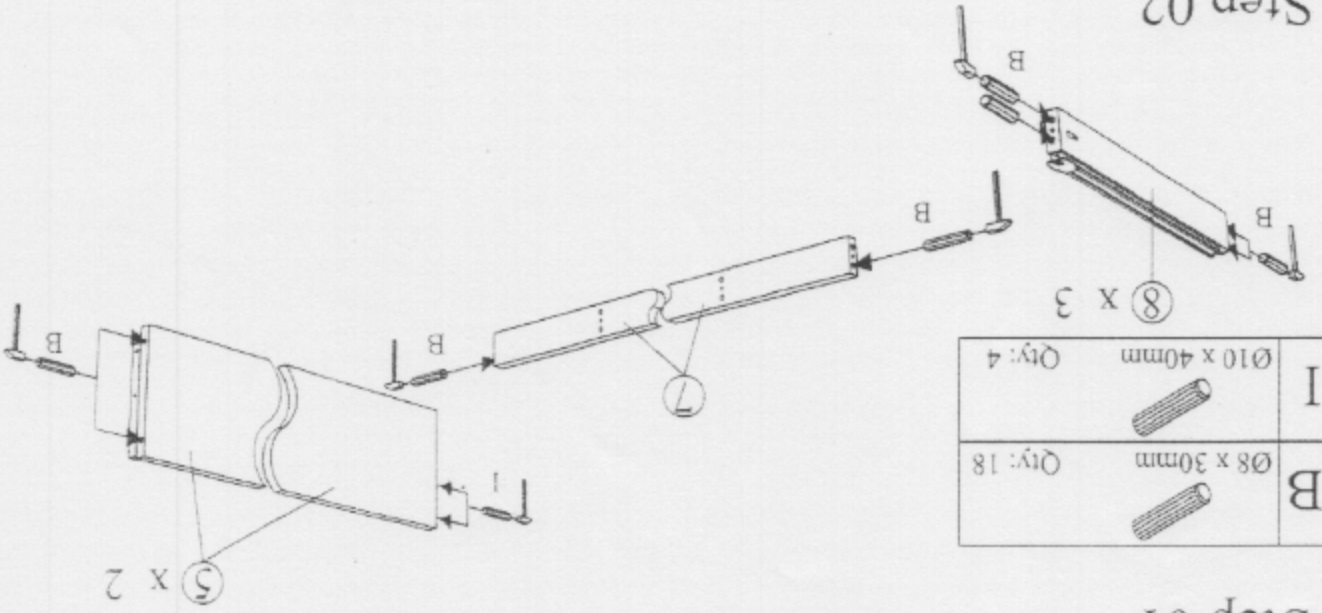

Step 02

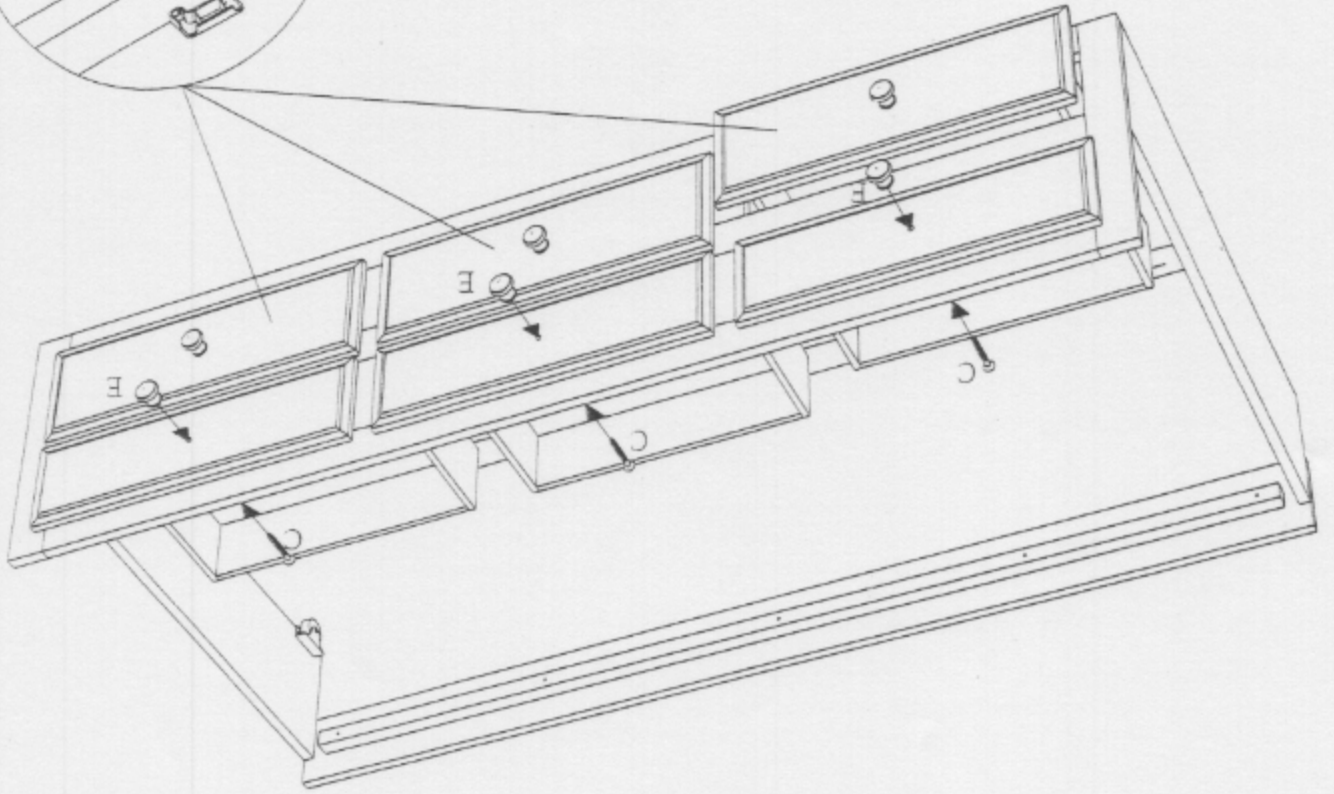
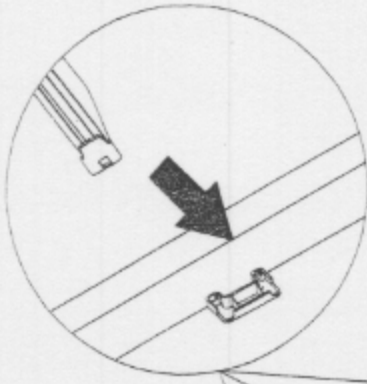

B		Qty: 18	I		Qty: 4
---	--	---------	---	--	--------

Step 01

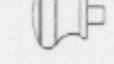
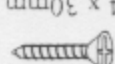

F		Ø4 x 30mm	Qty: 6	M		Ø4 x 20mm	Qty: 18
F		Ø8 x 20mm	Qty: 06	E			Qty: 06

