



#WL-122-3 BUNK BED

SAFETY WARNINGS

1. Follow the information on the warnings appearing on the upper bunk end structure and on the carton. Do not remove warning label from bed.
2. Always use the recommended size mattress or mattress support, or both, to help prevent the likelihood of entrapment or falls.
3. Surface of mattress must be at least 5 inches (127mm) below the upper edge of guardrails.
4. Do not allow children under 6 years of age to use the upper bunk.
5. Prohibit more than one person on the upper bunk
6. Periodicall, check and ensure that the guardrail, ladder, and other components are in their proper position, free from damage, and that all connectors are tight.
7. Do not allow horseplay on or under the bed and prohibit jumping on the bed.
8. Always use the ladder for entering and leaving the upper bunk.
9. Do not use substitute parts. Contact the manufacturer or dealer for replacement parts.
10. Use of a nightlight may provide added safety precaution for a child using the upper bunk.
11. Always use guardrail on both long sides of the upper bunk. If bunk bed will be placed next to the wall, the guardrail that runs the full length of the bed should be place against the wall to prevent entrapment between the bed and wall.
12. The use of water or sleep flotation mattresses is prohibited.
13. Keep these instruction for future reference.

STRANGULATION HAZARD - Never attach or hang items to any part of the bunk bed that are not designed for use with the bed ; for example, but not limited to, hooks, belts and jump ropes.

SIZE OF MATTRESS AND FOUNDATION

Use only mattress, foundation and deck combined which is 74-75 inches long and $37\frac{1}{2}$ - $38\frac{1}{2}$ inches wide on twin upper bunk or 53" - 54" wide on full upper bunk

Ensure thickness of mattress and foundation combined does not exceed 9 inches and mattress and is at least 5 inches below upper edge of guardrails.

Replacement parts, may be obtained from any Donco dealer or directly from us at the below address.

**6801 Snowden Road Fort
Worth, Texas 76140**



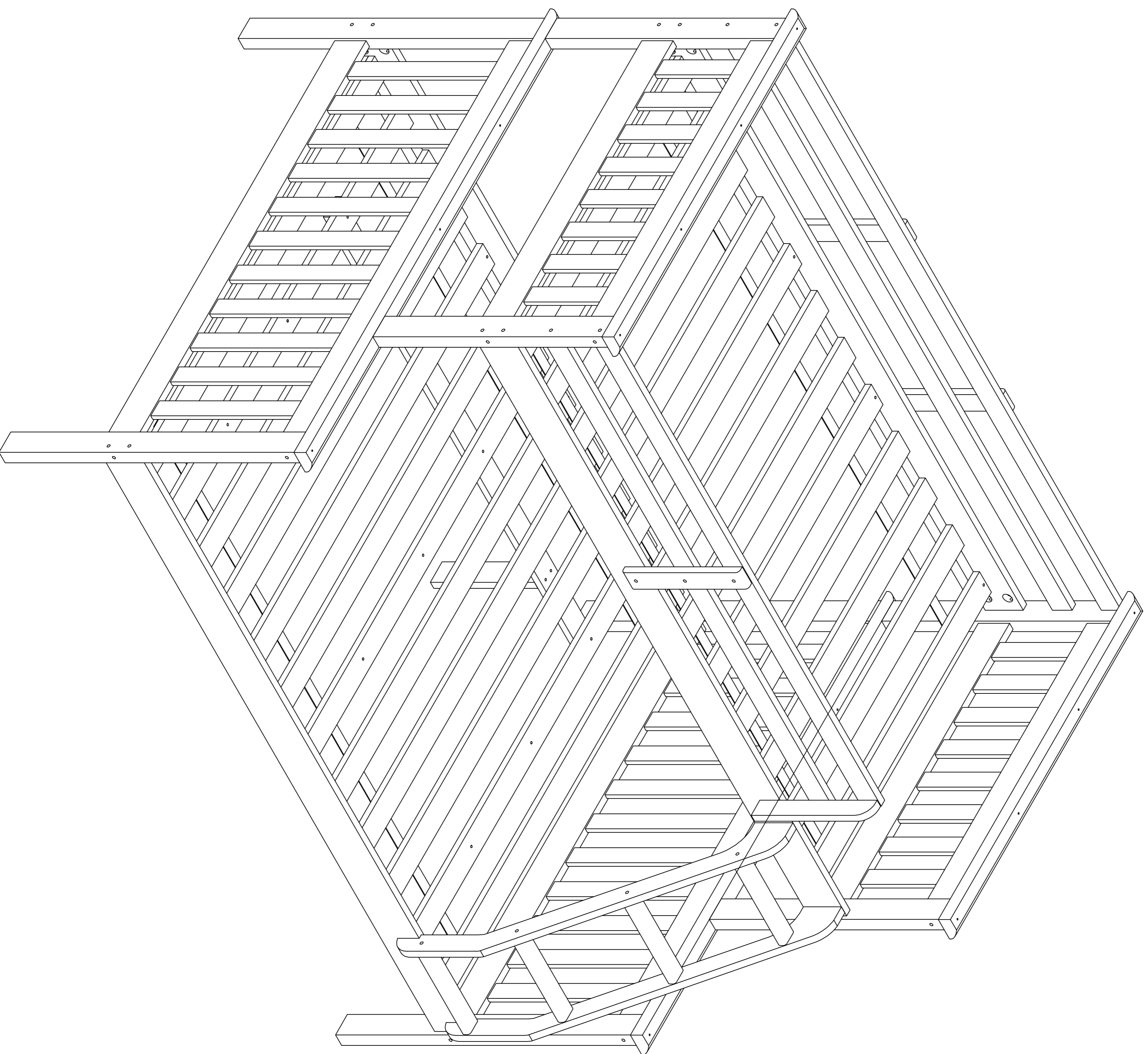



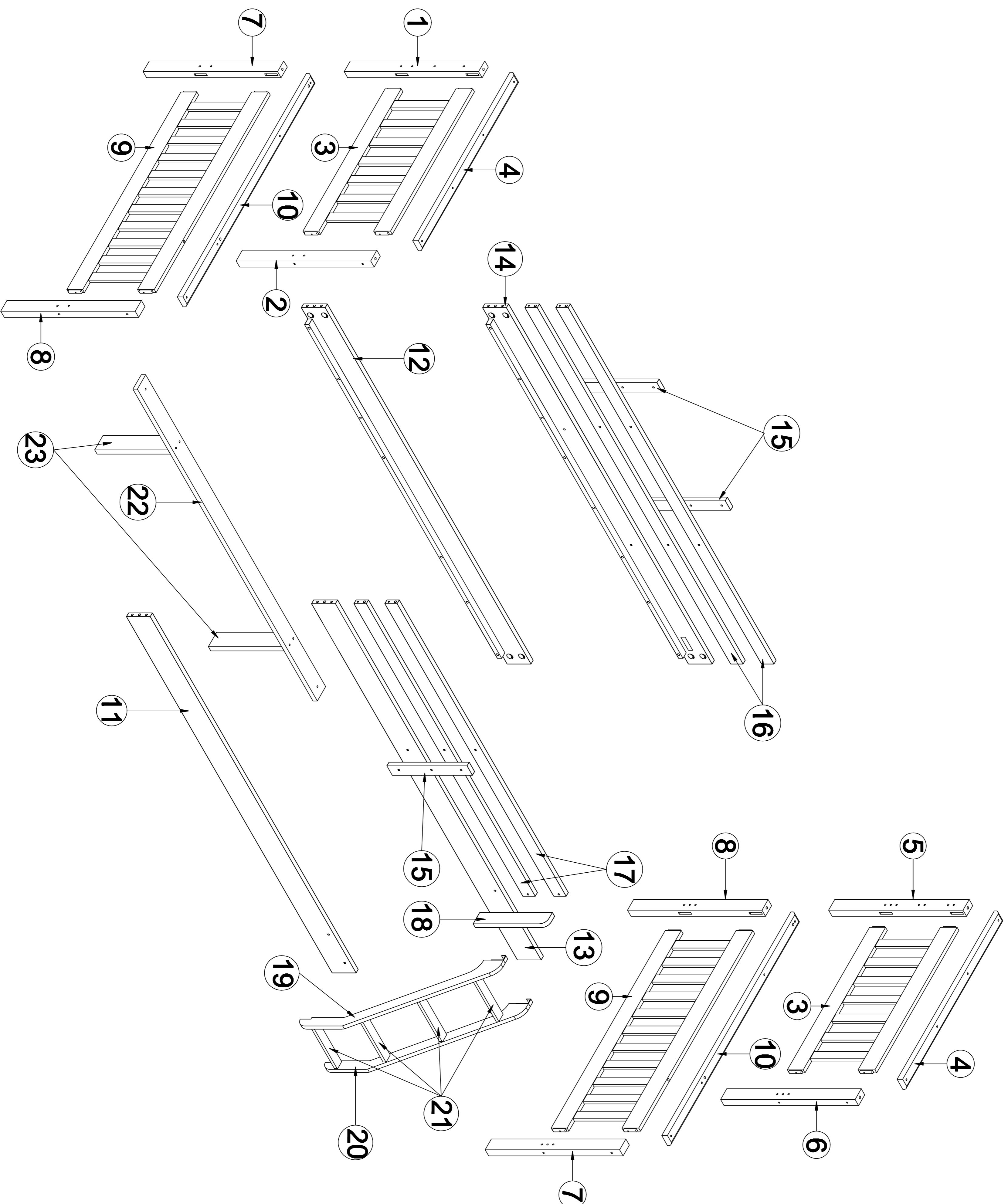

ASSEMBLY INSTRUCTIONS - BUNK BED

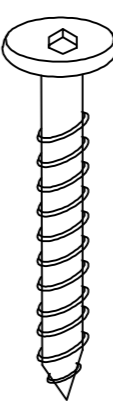
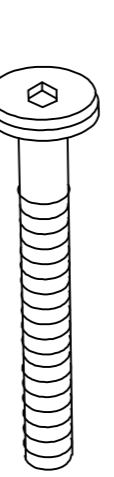

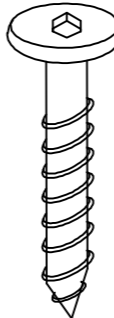
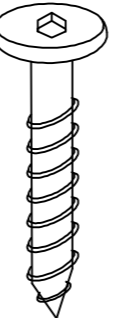
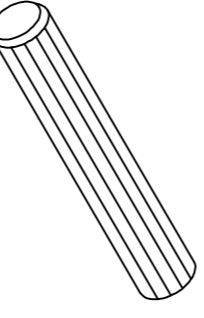
ASSEMBLY INSTRUCTIONS - BUNK BED

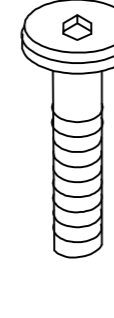
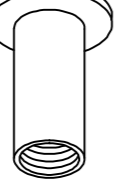
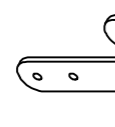
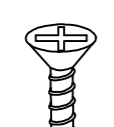
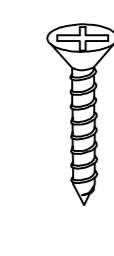
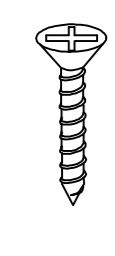

COMPLETE HARDWARE LIST

A	 Ø6x100mm	16pcs
	 Ø6x80mm	16pcs
B	 Half Moon	16pcs
	 Ø6x50mm	8pcs
C	 Ø6x65mm	6pcs
D	 Wood Dowell Ø12x110mm	4pcs
E	 Ø10x40	30pcs
F	 Ø4x35mm	18pcs
	 Allen Key	1pc
H	 Ø6x35mm	14pcs
	 Female Half Moon	9pcs
I	 Female Half Moon	9pcs
J	 Female Half Moon	2pcs
K	 Ø4x35mm	6pcs
M	 Ø4x30mm	7pcs
N	 Ø4x15mm	8pcs

ASSEMBLY INSTRUCTIONS - BUNK BED



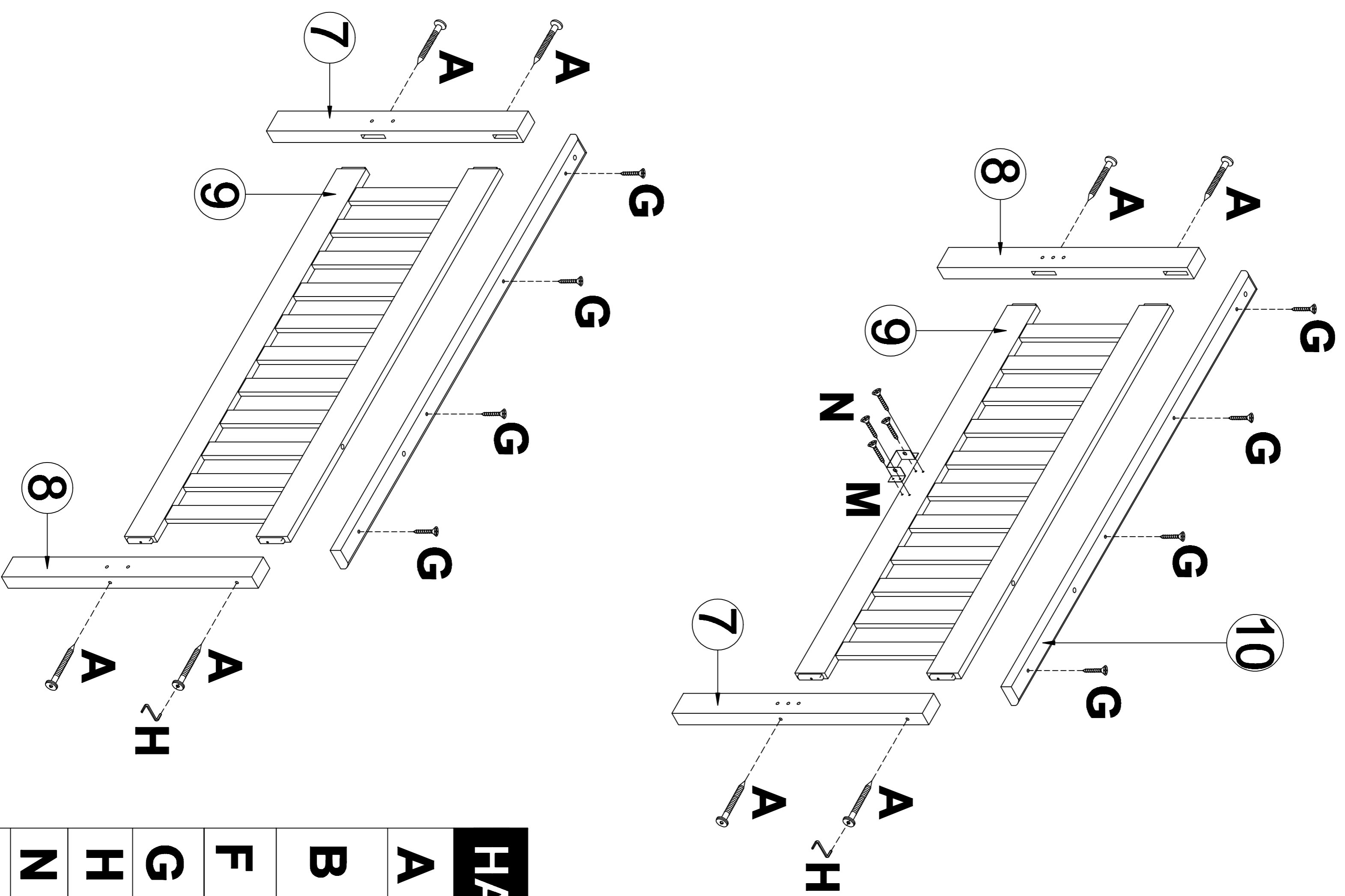

Step 1

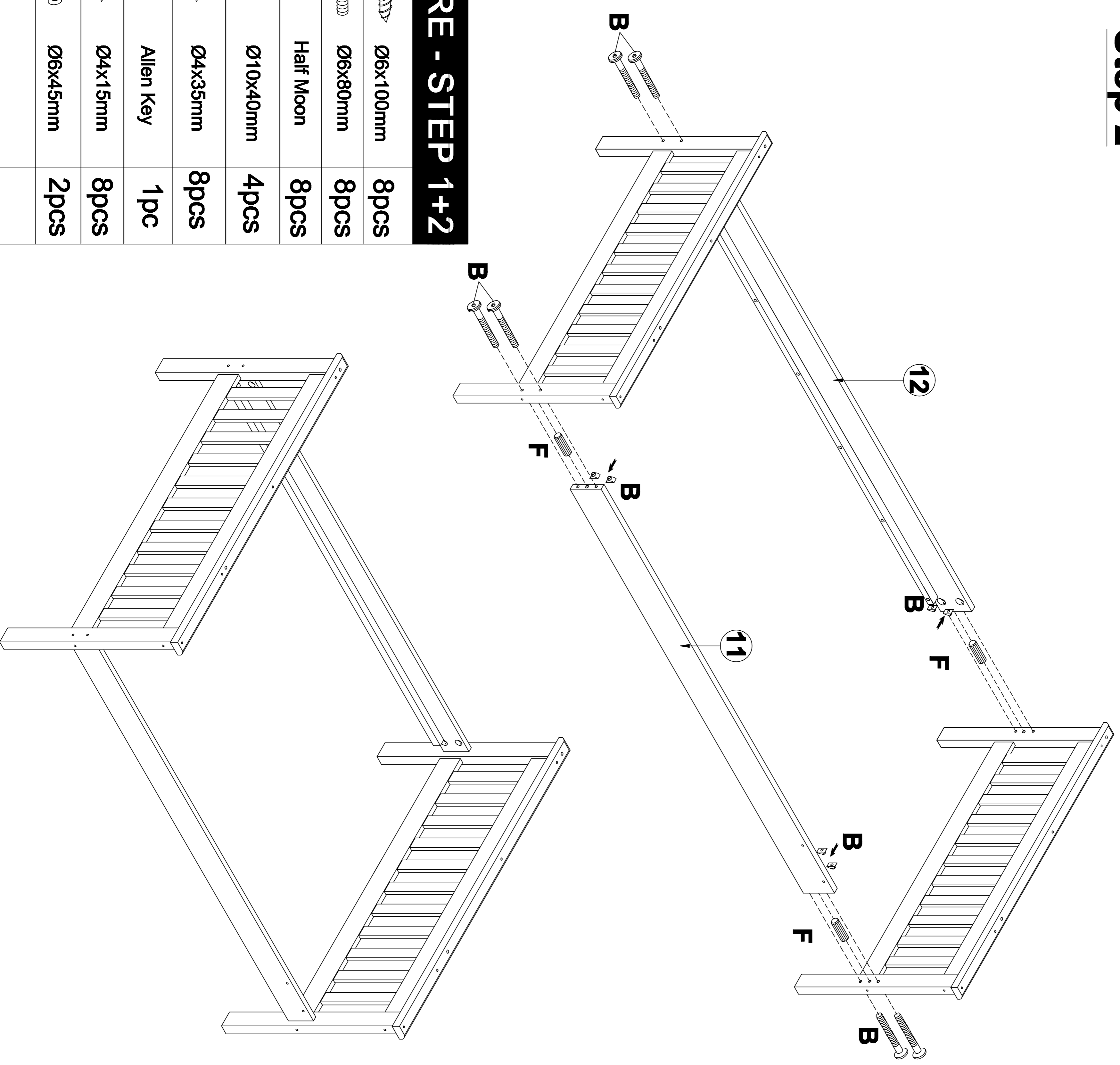

Step 2

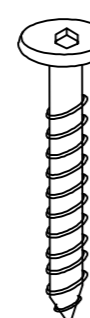
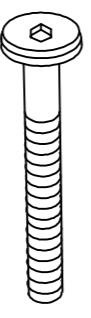
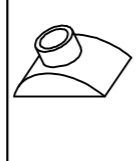

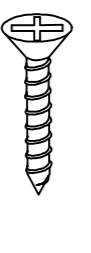
HARDWARE - STEP 1+2

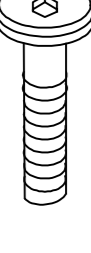
A	 Ø6x100mm	8pcs
B	 Ø6x80mm	8pcs
	 Half Moon	8pcs
F	 Ø10x40mm	4pcs
G	 Ø4x35mm	8pcs
H	 Allen Key	1pc
N	 Ø4x15mm	8pcs
O	 Ø6x45mm	2pcs

ASSEMBLY INSTRUCTIONS - BUNK BED



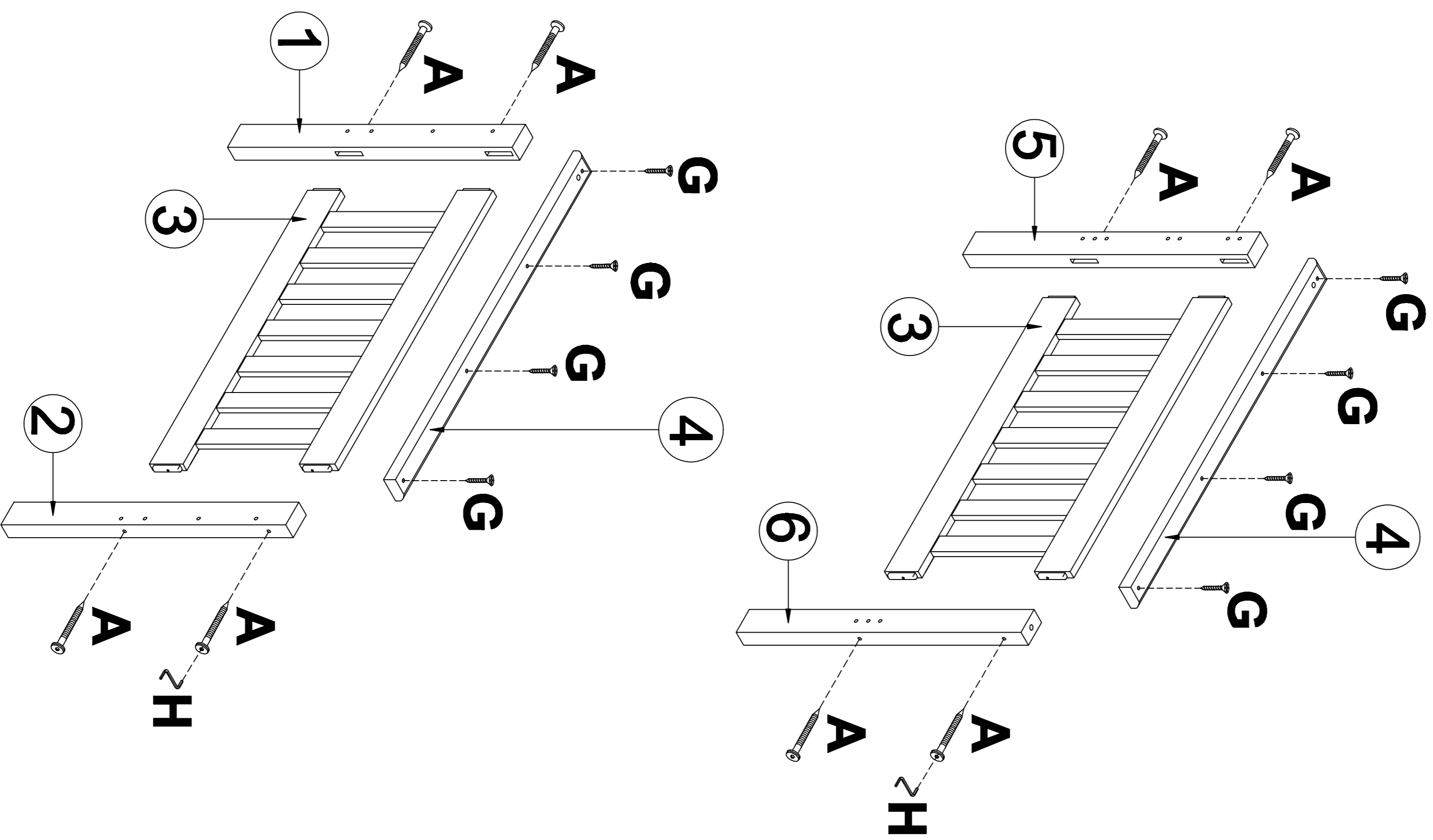

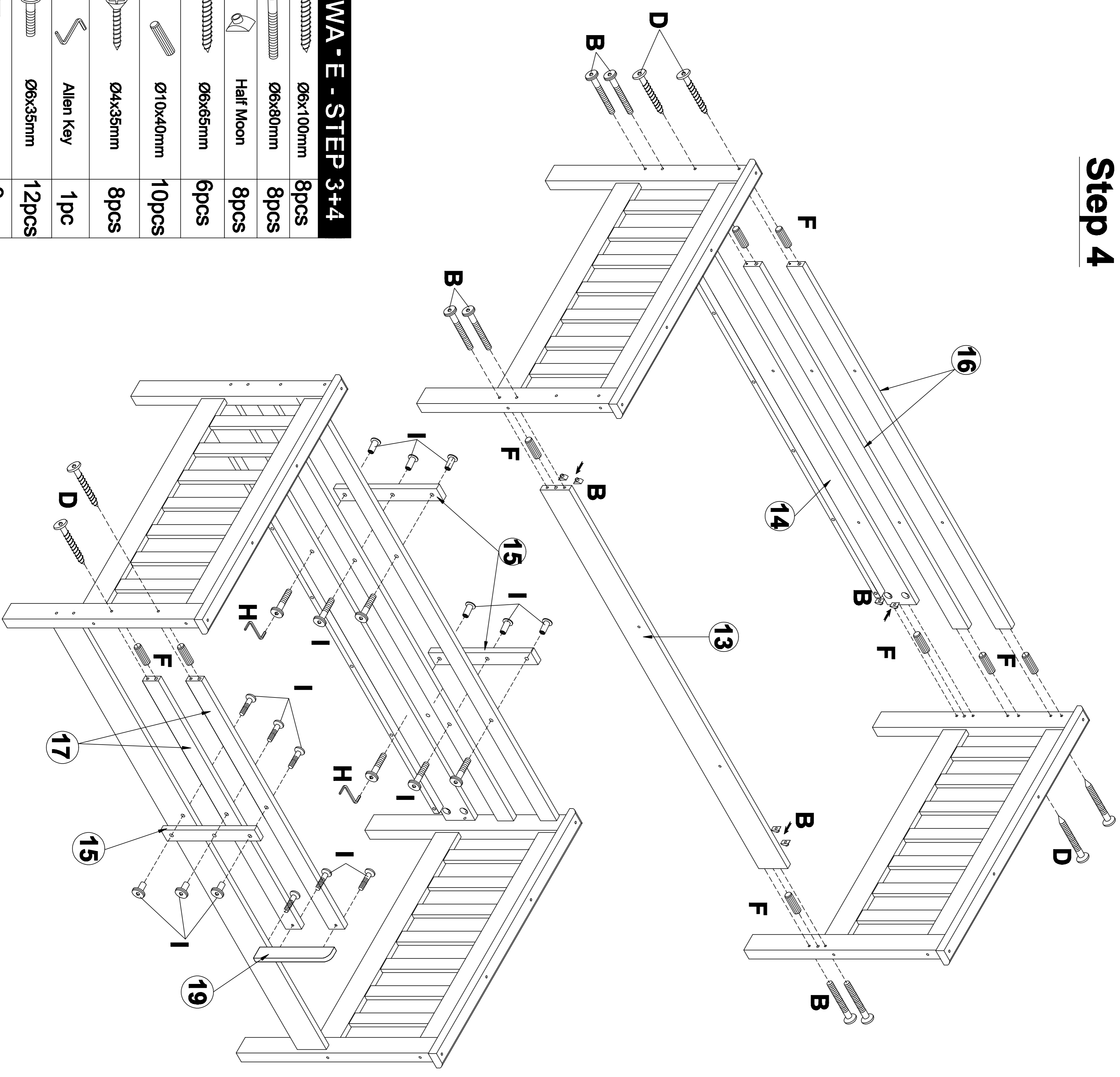

Step 3

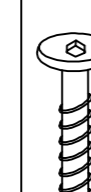
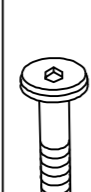

Step 4

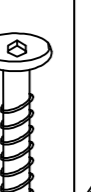

HA - DWA - E - STEP 3+4

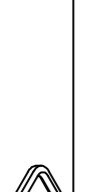
A	 Ø6x100mm	8pcs
B	 Ø6x80mm	8pcs
	 Half Moon	8pcs
D	 Ø6x65mm	6pcs
F	 Ø10x40mm	10pcs
G	 Ø4x35mm	8pcs
H	 Allen Key	1pc
I	 Ø6x35mm	12pcs
	 Female Half Moon	9pcs

ASSEMBLY INSTRUCTIONS - BUNK BED

Important : Assembly Instructions for 8 or 24 slat options are located in slat box

Step 5

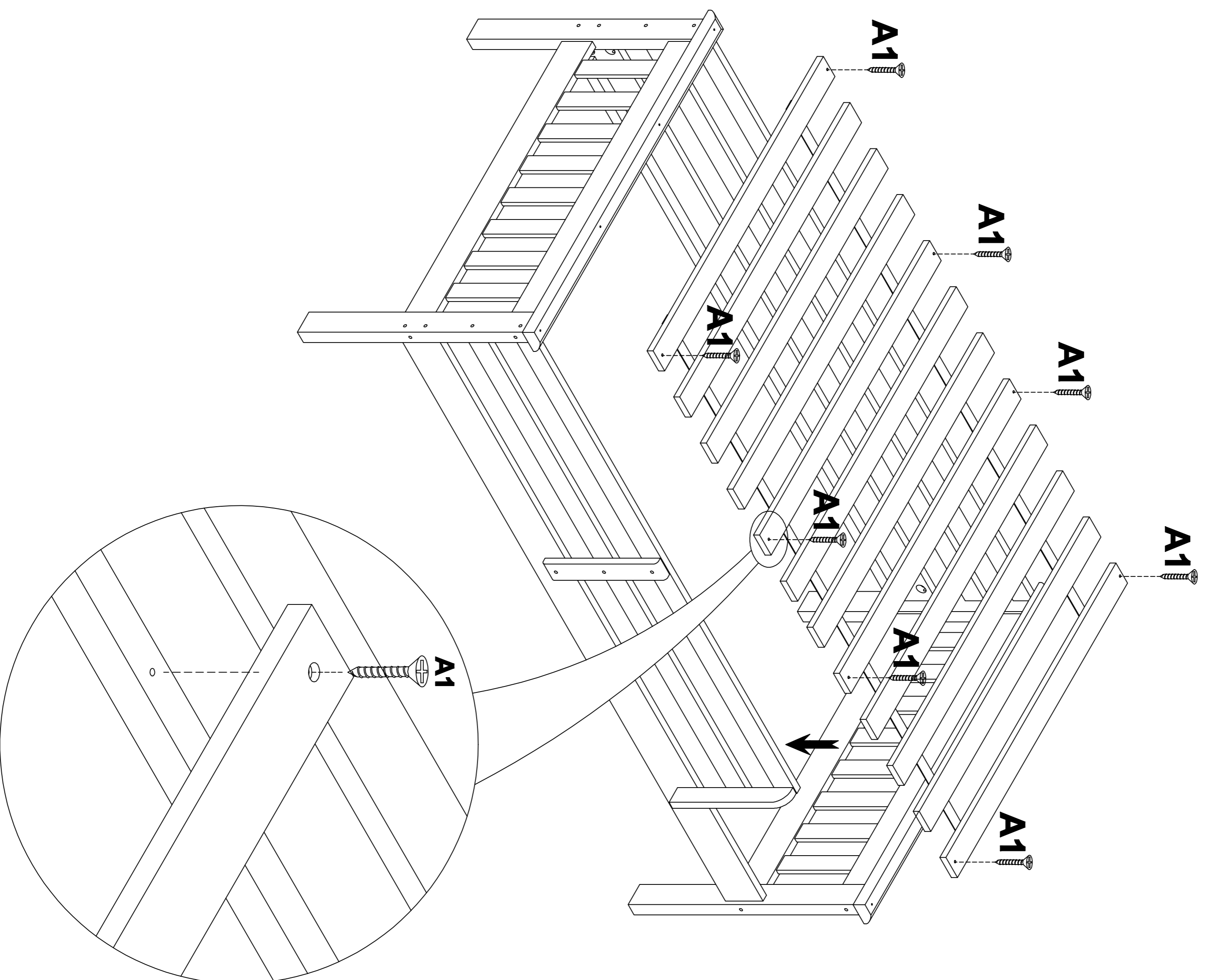

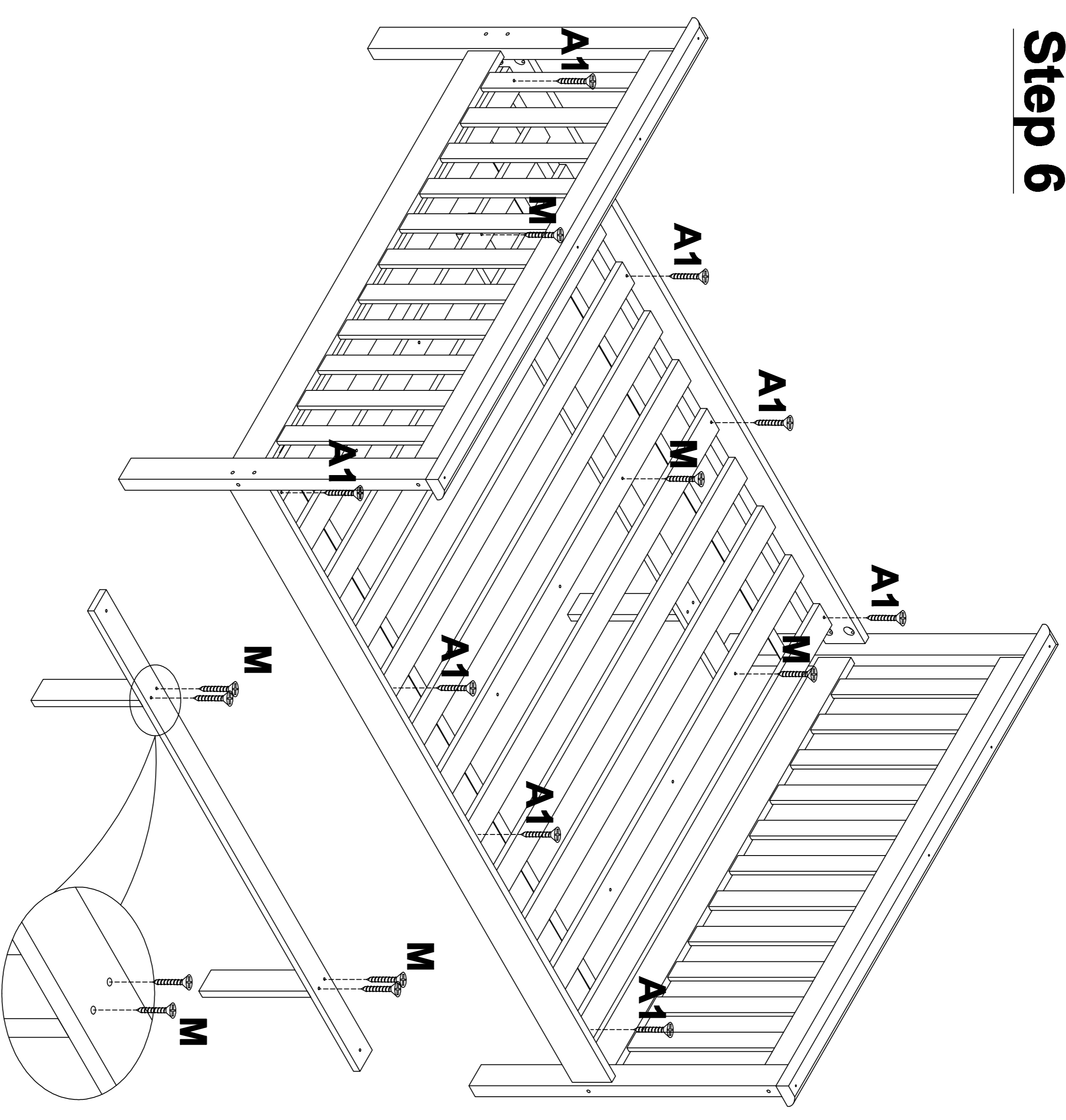

Step 6



NOTED: Center Support Rail for Full bed has two attachment positions :

- 1) For use with Storage Drawers (Support is in the center of the Slats).
- 2) For use with a Trundle Bed (Support is toward the back end of the Slats).
- 3) Either position can be used if you do not plan to use either a Trundle or Storage Drawers.

HARDWARE - STEP 5+6

A1		Ø4x35mm	16pcs
M		Ø4x35mm	7pcs

ASSEMBLY INSTRUCTIONS - BUNK BED



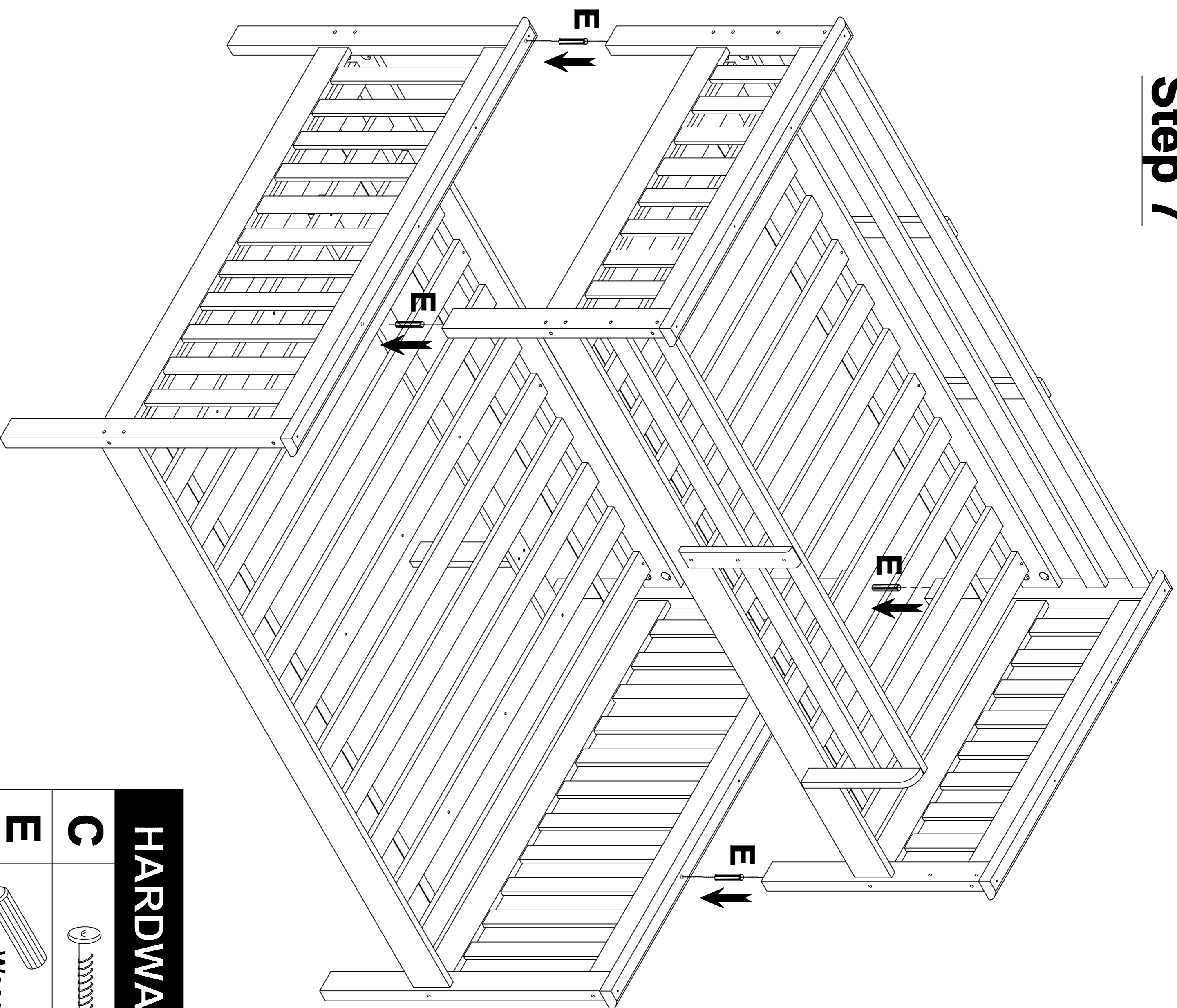

Step 7

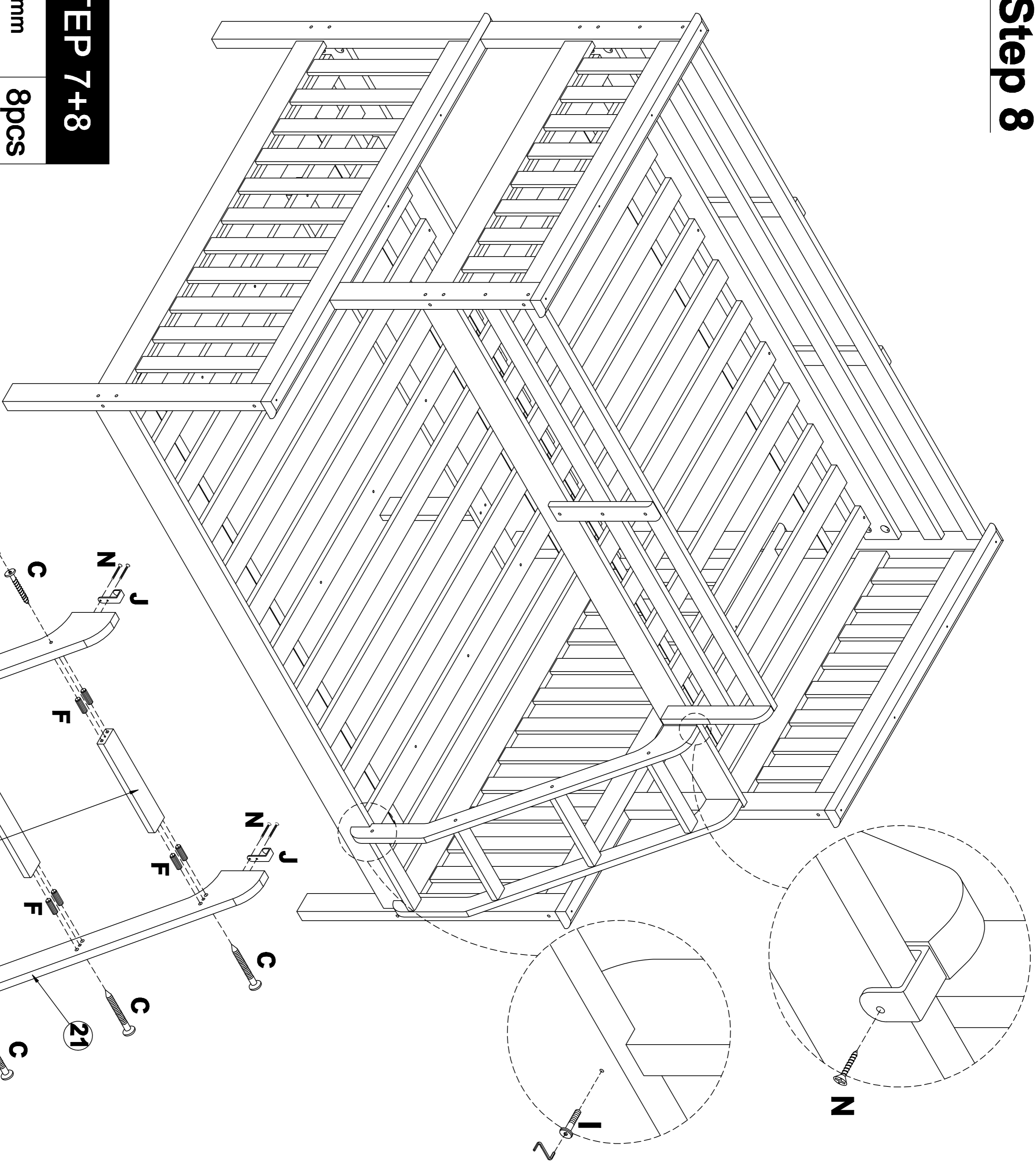

Step 8

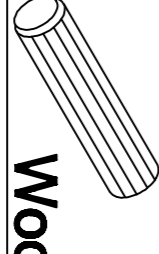

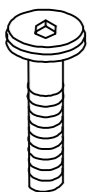
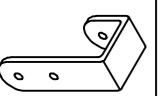
HARDWARE - STEP 7+8

C		Ø6x50mm	8pcs
E		Ø12x110mm Wood dowell	4pcs
F		Ø10x40mm	16pcs
H		Allen Key	1pc
I		Ø6x35mm	2pcs
J			2pcs
N		Ø4x35mm	6pcs

