

Assembly Instructions

Page 1 of 4

Parts in this box :

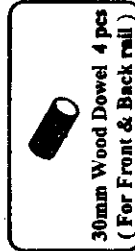
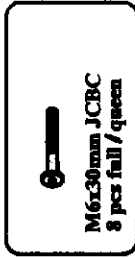
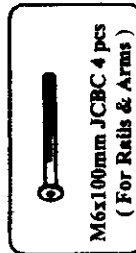
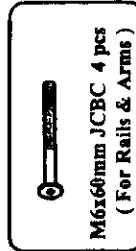
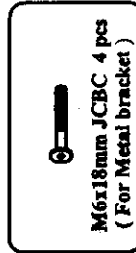
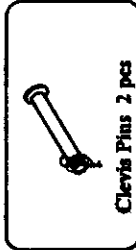

Components :

For Size :

CHAIR
LOVESEAT
FULL
QUEEN

NOTE :

1. These Assembly Instructions show Full size frame assembly:
Procedure is the same for all size.
2. Your arm style may vary from the one shown.
Procedure is the same for styles.

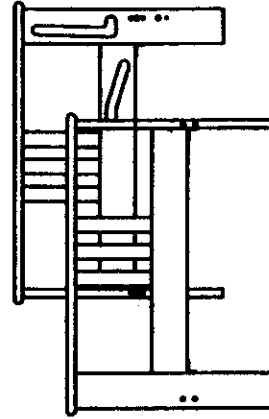
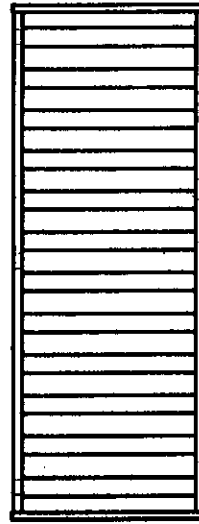
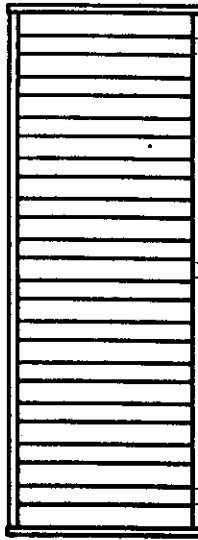

- 2 pcs (full & queen)
For Back Deck



- 2 pcs (full & queen)
For Seat Deck

Assembly Instructions

Before beginning the actual assembly of your futon frame, make sure that all of the parts described on the front page are included in your futon's box.

STEP 1

ASSEMBLE BRACKET & RAILS TO ARM

1. Using the allen key attach the brackets to the bottom holes of the inside leg of the arm as shown in *fig. 1*
2. Insert wood dowel to the end of each stretcher rail as shown in *fig. 2*
3. Using the 60mm & 100mm bolts and barrel nut assemble the stretcher rail to the arms as shown in *fig. 3*

- The front and back rails are marked differently.
- All metal brackets on the rails are face up.
- Do not tighten until the back is inserted into the frame.

Install the Metal Bracket to Arm

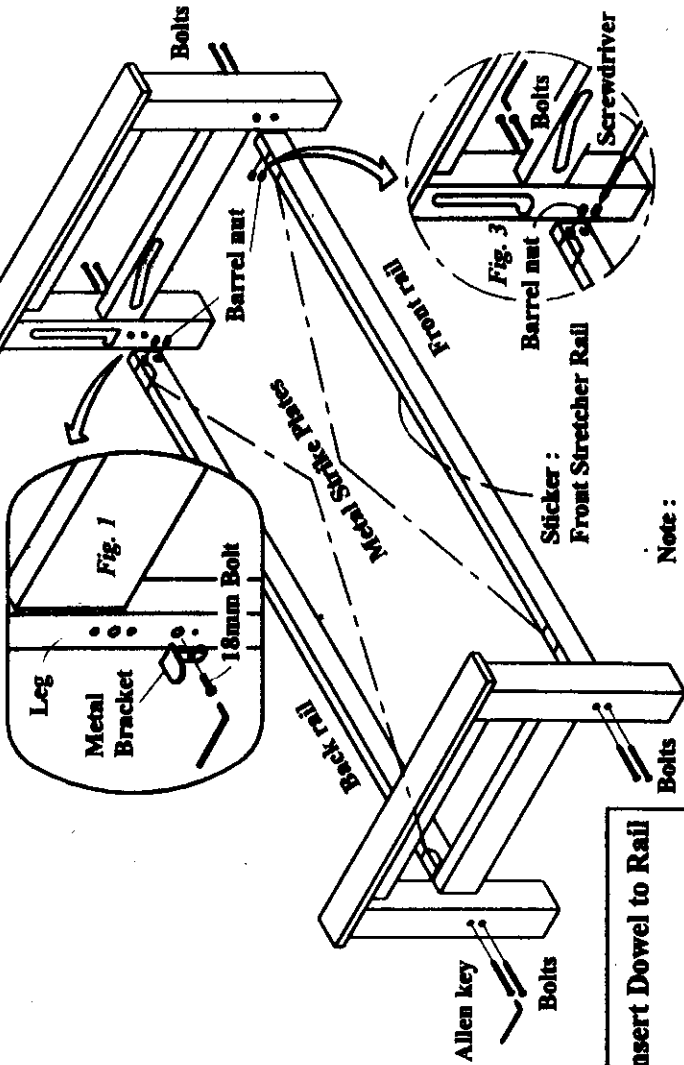

Note:

Be sure the holes are free of wood chips and saw dust.

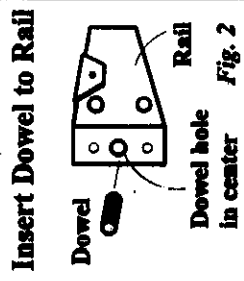

Slat support (Customer assemble)

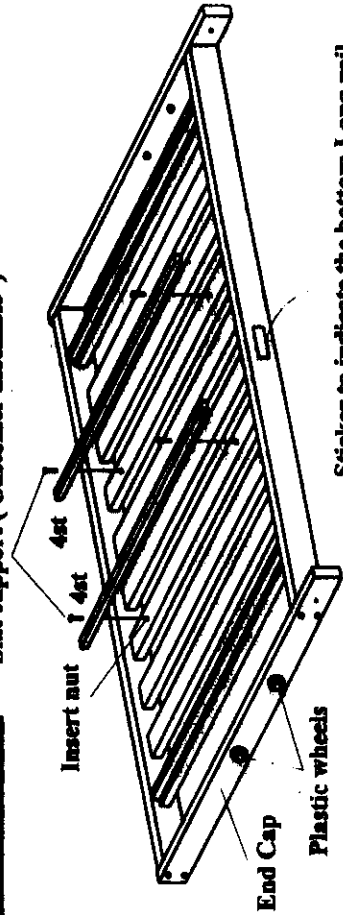

STEP 2

Placement of Slat Supports

1. Turn seat decks upside down.
2. Fit Slat supports into the decks
3. Assembly to 4st Slats from each end. (Full / Queen size)
4. Screw 30mm bolts into insert nuts provided on slats.

NOTE

- The carved out Slat support place in Seat Deck
- The Seat Deck is the shorter of the two Decks.

Assembly Instructions

Page 3 of 4

STEP 3

FIT BACK DECK INTO POSITION

1. Place the Back Deck between both bifold arms. Fit the wheel into the grooves in the arms.
2. Insert one end first, then gently lower the other end into position.
3. When you have the Back deck-fitted lying flat, tighten all the Bolts. From the back, lift the Back Deck to up right as illustrated.
4. Gently insert wood button to cover the bolt hole

NOTE :

This step can be tricky - it is best with two people.

Label shows top side

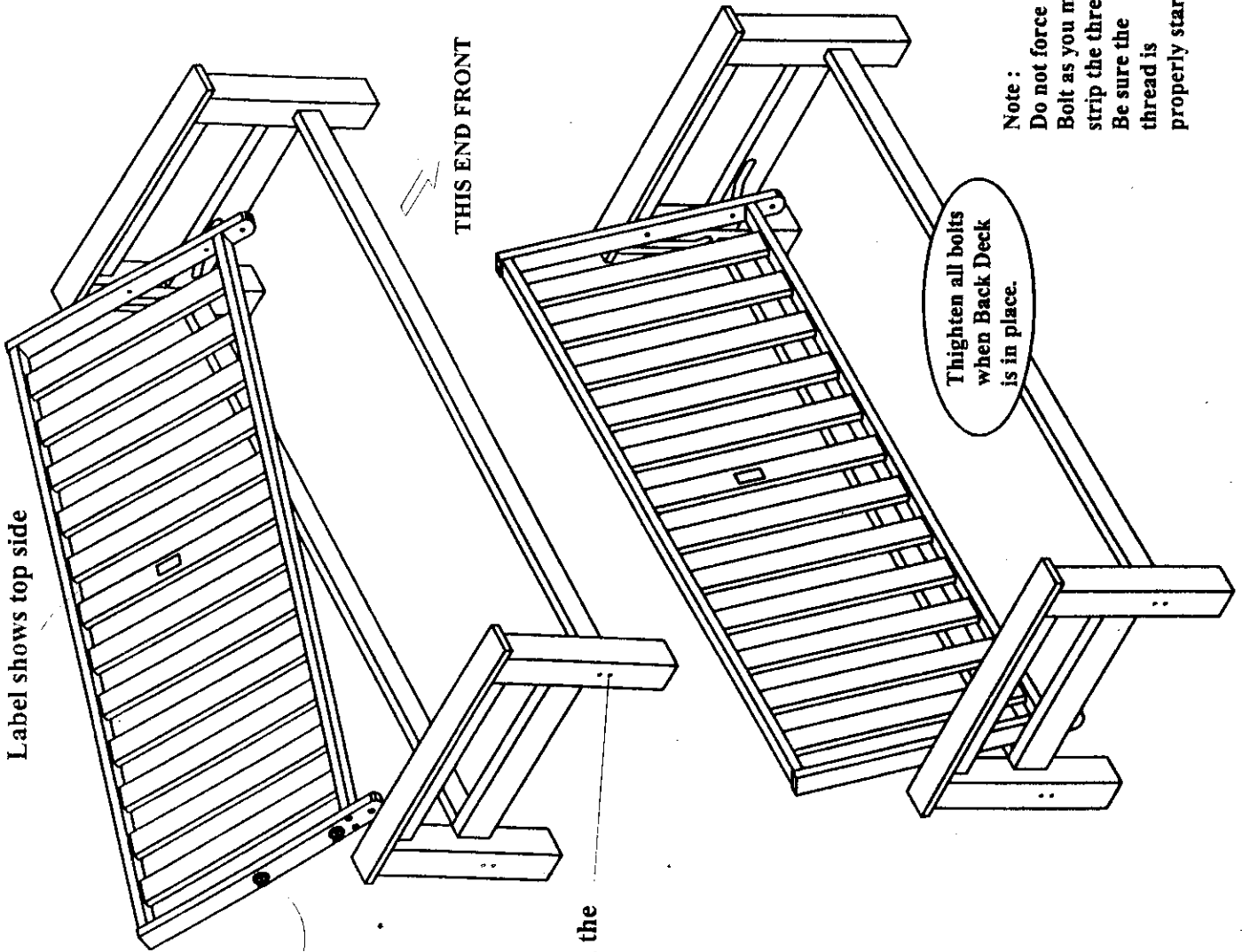

Note :

1. Guide the plastic wheel into the arm grooves.
2. Be careful not to scratch the arms with the plastic wheel.

Ensure bolts on the Arms are loose

Note :

Do not force the Bolt as you may strip the thread. Be sure the thread is properly started.

Tighten all bolts when Back Deck is in place.

Assembly Instructions

Page 4 of 4

STEP 4

FIT SEAT DECK POSITION

1. Fit the assembled seat deck between the Bifold arms and into the back deck as shown.
2. Use 55mm Bolt to connect the two decks.

Note :
Your frame is now completely assembled. Read the operating instructions before continuing.

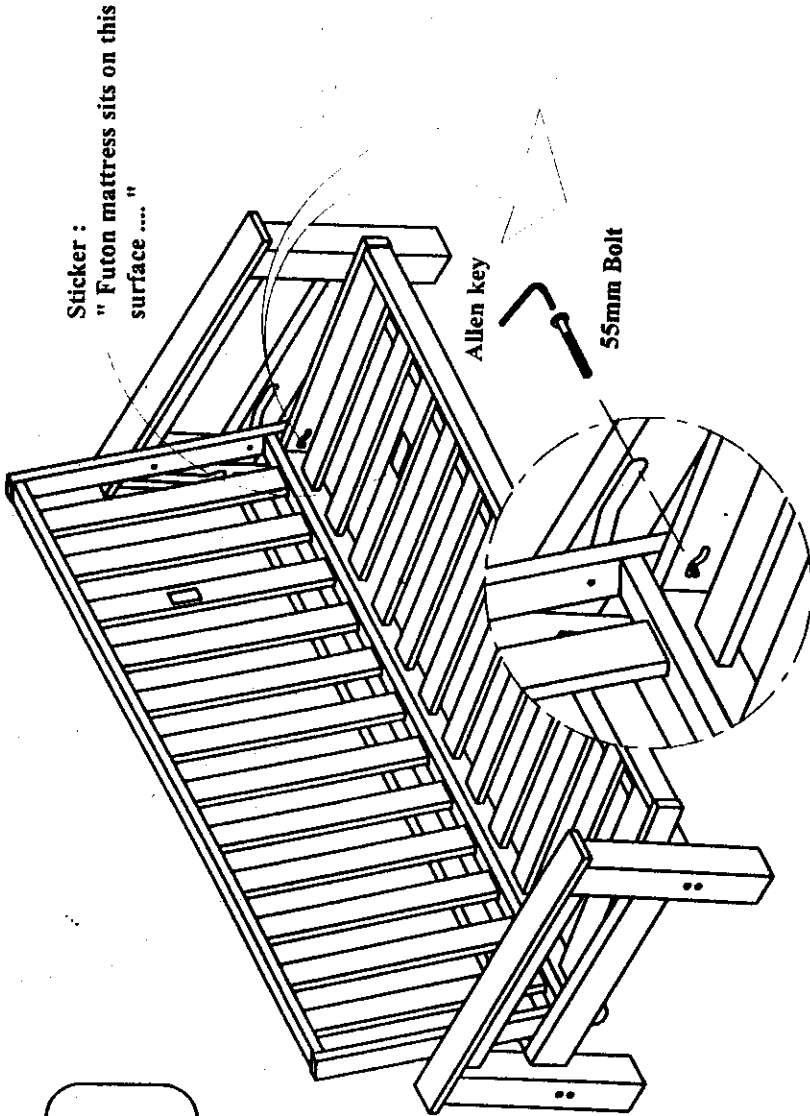

STEP 5

FOR QUEEN SIZE ONLY

ATTACH SMALL LEG

IMPORTANT :
Orientation of the Queen Small Leg, note that the exposed part of the metal nut in the leg should be oriented away from the bolt for proper assembly.

