

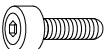

# ASSEMBLY INSTRUCTION

Model: 2611ATWG / 2611BTWG / 2611CTWG - TWIN BED

## Hardware List

<b>A</b>		Bolt M8*20	8pcs
<b>B</b>		Allen key 6	1pc
<b>C</b>		Screw Ø4*30	24pcs

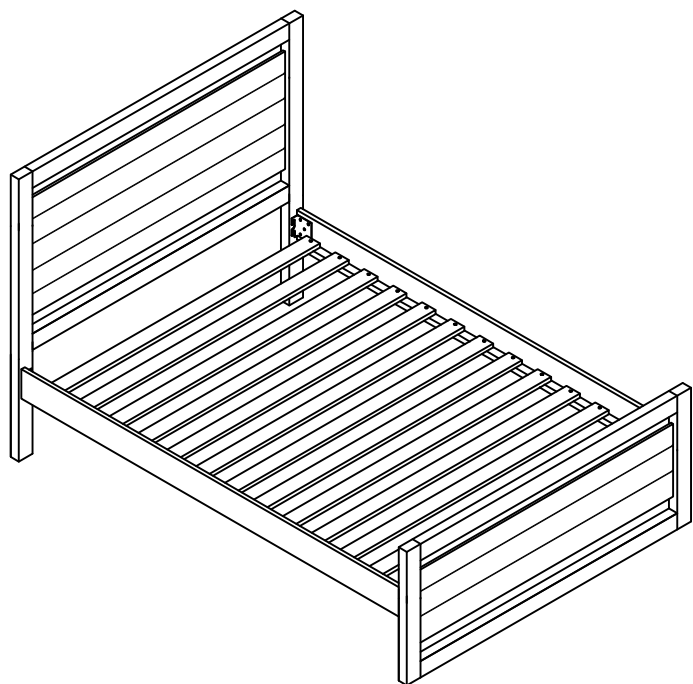

FINISH

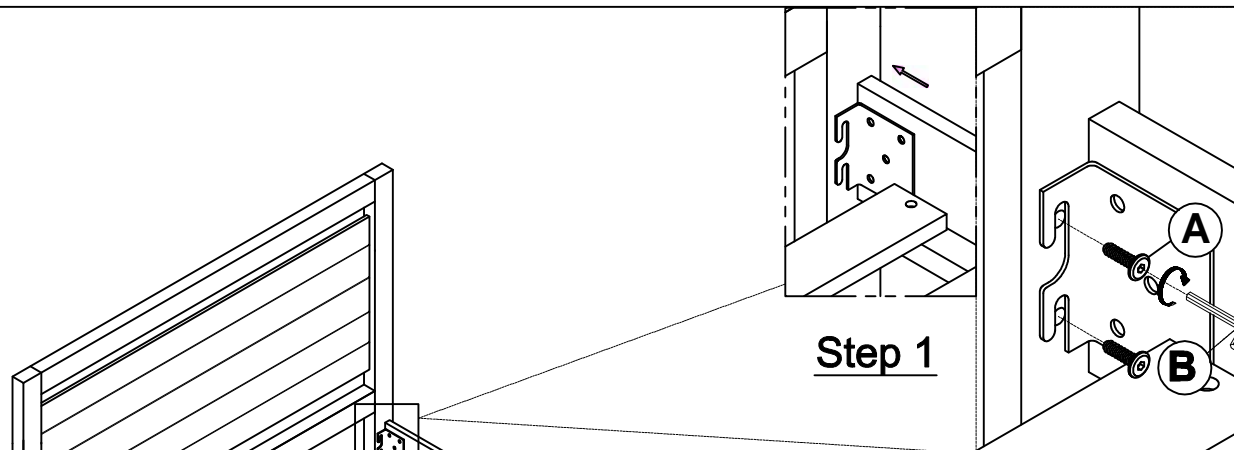

Step 1

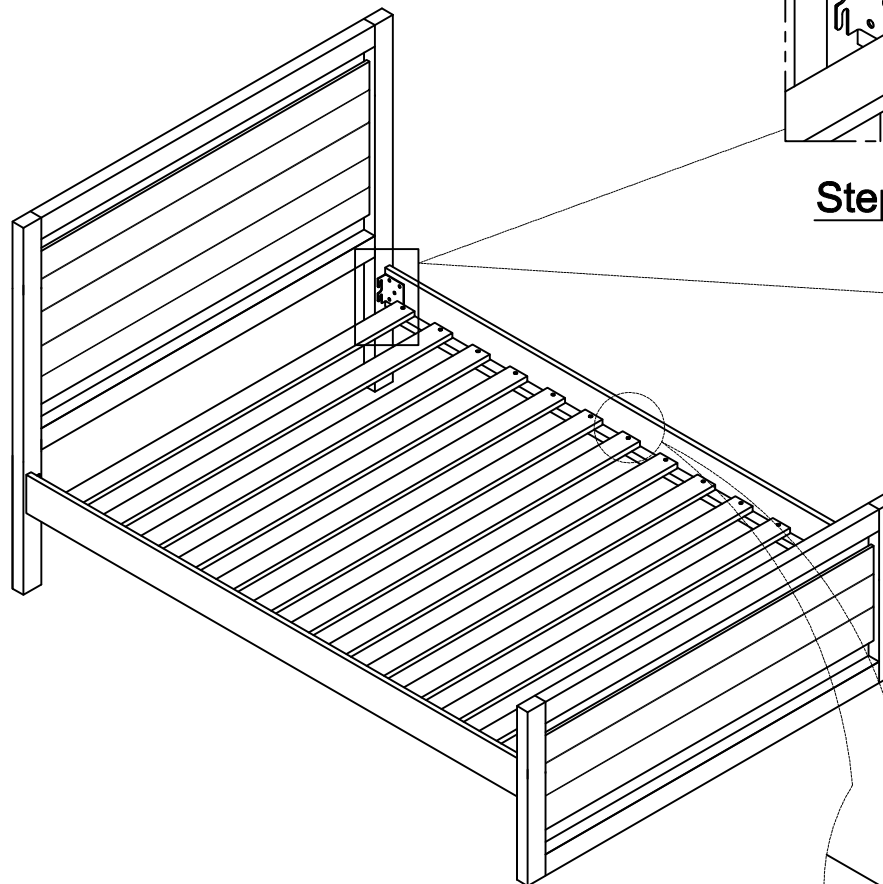

Step 2

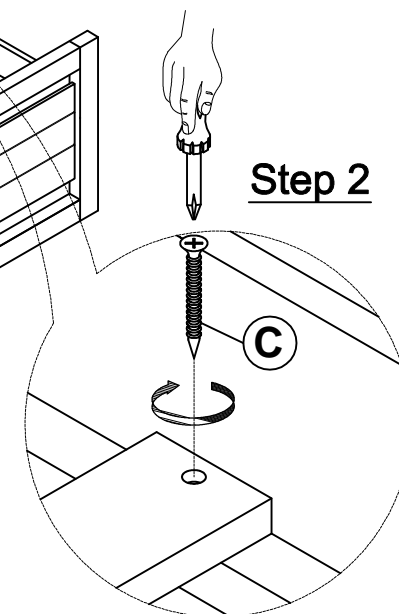

MADE IN VIETNAM