

PARTS IDENTIFICATION

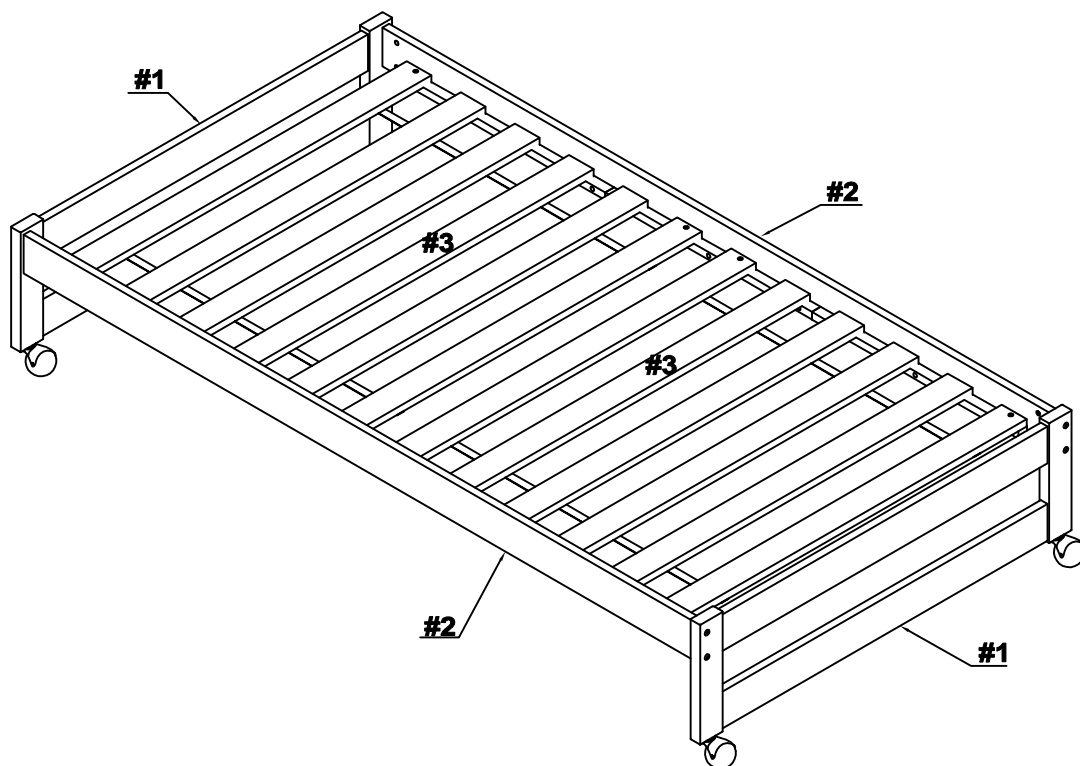



ITEM	DESCRIPTION	QTY
#1	HEADBOARD / FOOTBOARD	02
#2	BED RAILS	02
#3	SLATS	02 Sets (12pcs)



ASSEMBLY INSTRUCTIONS - MODULAR LOFT TWIN CASTER BED

ITEM # 1205

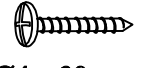
BOX : 5

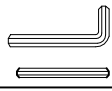
A		Qty:8	B		Qty: 8	C		Qty:4	D		Qty:8
	1/4" x 80 mm			1/4"x13mm			Ø10 x 40mm			Ø4 x 30 mm	
	Large Allen Bolt			Barrel Nut			Wooden Dowel			Wood Screw	
E		Qty: 4	F		Qty: 1						
	98x66x57mm			Allen Key		Qty: 1					
	Wheels										

Step 1:

- Lay the **Headboard / Footboard** (1) and **Bed Rails** (2) on the floor and organize them in a similar configuration to assembly diagram.
 - Attach the **Wheels** (E) to the bottom face of the post of the **Headboard / Footboard** (1) as shown by inserting the metal pin of the Wheel (E) into the "Bushing" of the bottom of the corner post of both **Headboard / Footboard** (1).
 - Make sure that metal pin inserts fully into "Bushing"
 - Insert the **Wooden Dowels** (C) in the ends of the **Bed Rails** (2).
 - Align these **Wooden Dowels** (C) with the holes in the ends of the **Headboard / Footboard** (1) and insert.
 - NOTE: Assemble one **Headboard / Footboard** (1) at a time.
- Insert the **Barrel Nuts** (B) into the holes on the inside of the **Bed Rails** (2).
- Make sure that the hole in the side of the **Barrel Nuts** (B) faces toward the end of the rails.
 - Insert the **Large Allen Bolt** (A) through the **Headboard / Footboard** (1) and into **Barrel Nuts** (B) in the **Bed Rails** (2) one at a time and tighten.
 - Repeat this procedure for the opposite end **Headboard / Footboard** (1)
 - Lay the two sets of **Slats** (3) on the Support Cleat attached to the inside of the **Bed Rails** (2).
 - Align the edge of the first **Slat** (3) closest to the **Headboard / Footboard** (1) flush with the end of the Support Cleat on the inside of the **Bed Rails** (2).
 - Insert **Wood Screws** (D) through the holes in the ends of this first **Slat** (3) and tighten while keeping the outside edge of the Slat (3) and the end of the Support Cleat flush with each other.
 - Stretch the slat section toward the center of the Bed until tight.
 - Insert **Wood Screws** (D) through the holes in the ends of this last **Slat** (3) and into the Support Cleat and tighten.
 - Repeat this procedure with the other Slat Section on the opposite end of the Bed.

