

# ASSEMBLY INSTRUCTIONS

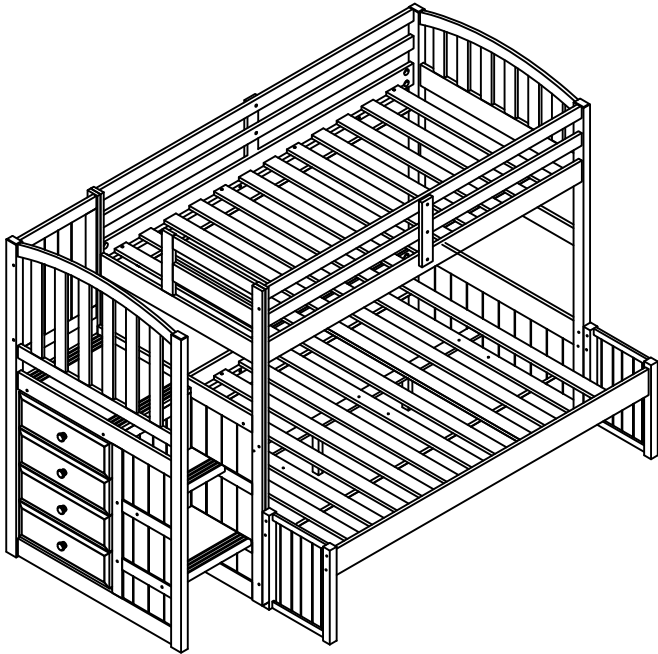



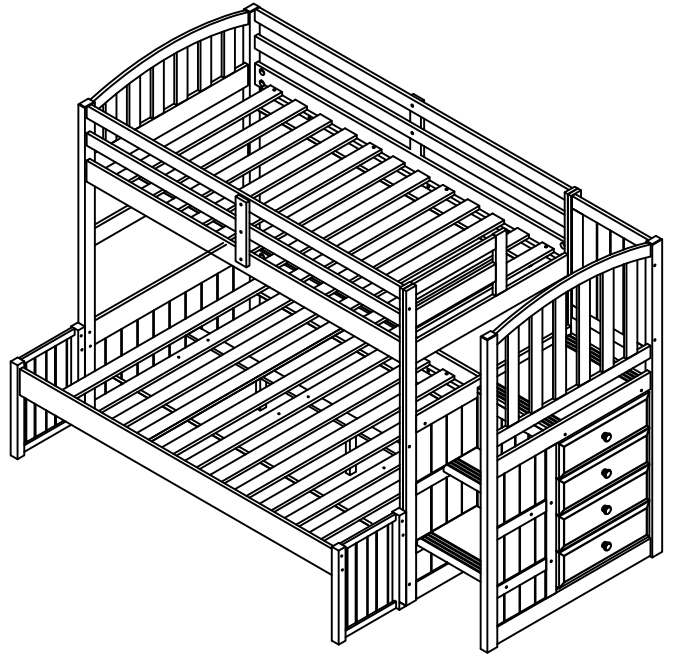

## #840 ARCH MISSION STAIR WAY WITH EXTENSION KIT

### LEFT ASSEMBLY



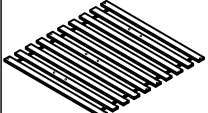
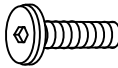
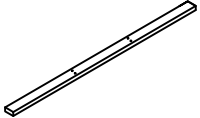

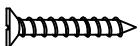
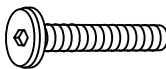

### RIGHT ASSEMBLY

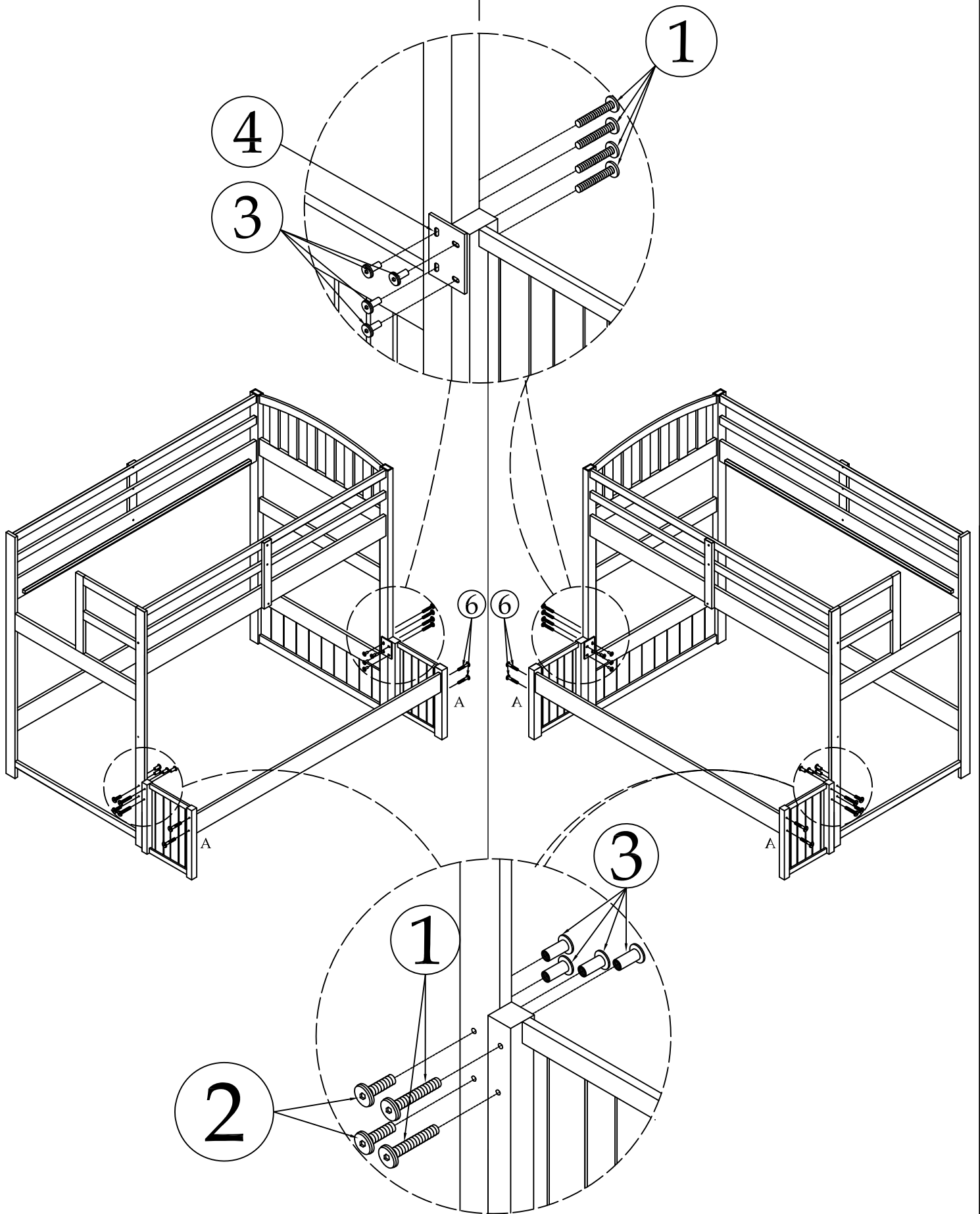

No.	Part List		Qty	No.	Hardware List		Qty
A		HB/FB Extension	2pcs	1		Bolt Ø6 x 35mm	6pcs
B		Slat Roll	1set	2		Bolt Ø6 x 10mm	2pcs
C		Support Rail	1pc	3		Female Half Moon	8pcs
D		Support Leg	2pcs	4		Metal Plate	2pcs
				5		Screw Ø4x30	13pcs
				6		Bolt Ø6 x 80mm	2pcs



1 = 6pcs  Bolt Ø6 x 35mm	2 = 2pcs  Bolt Ø6 x 10mm	3 = 8pcs  Female Half Moon	4 = 2pcs  Metal Plate	6 = 2pcs  Bolt Ø6 x 80mm
---	--	---	--	---

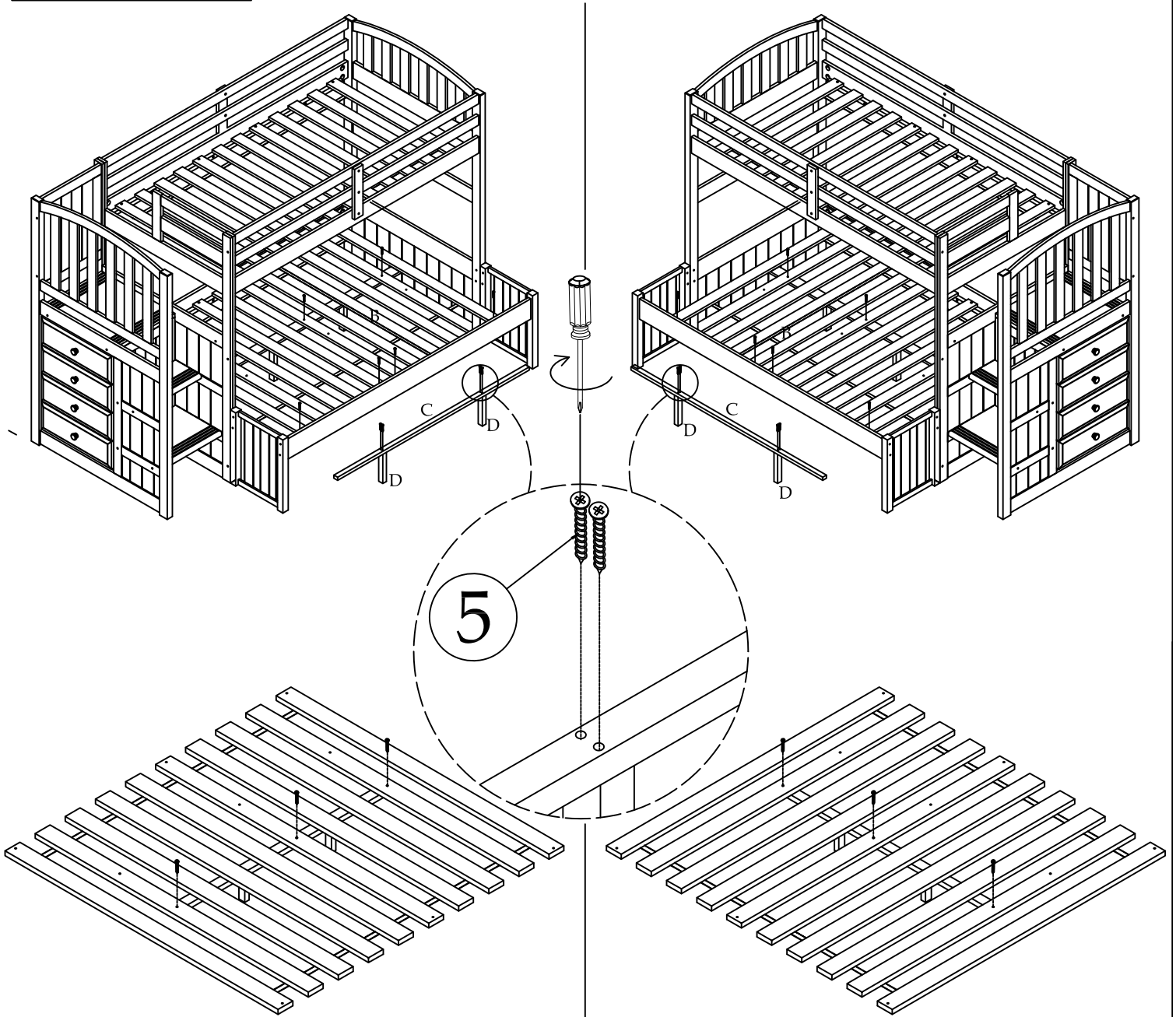

To use give Storage Drawers

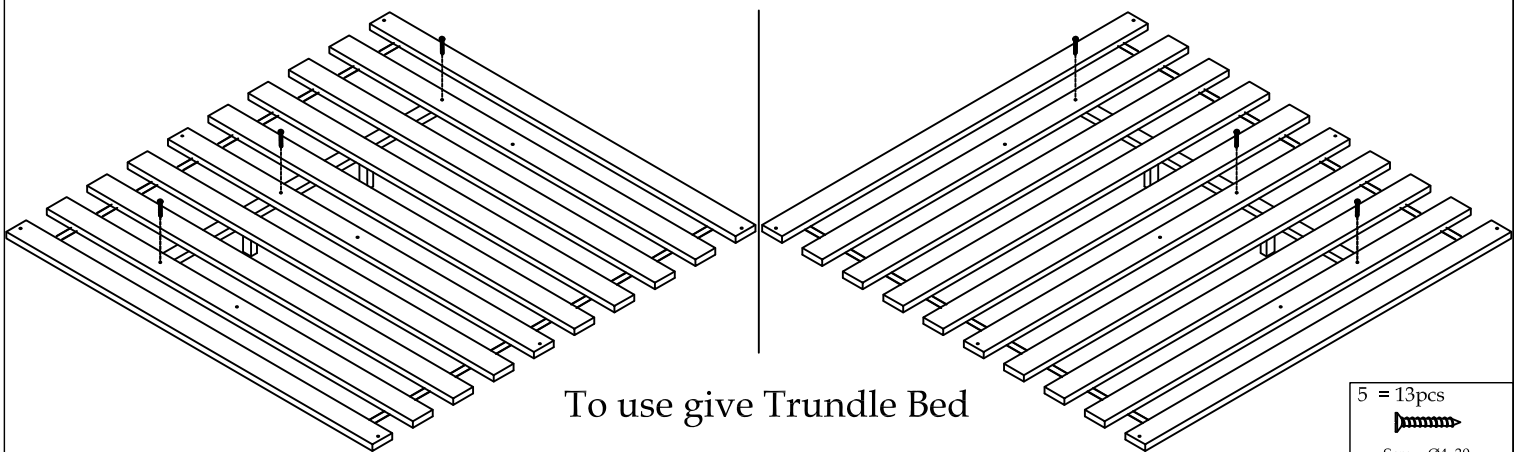





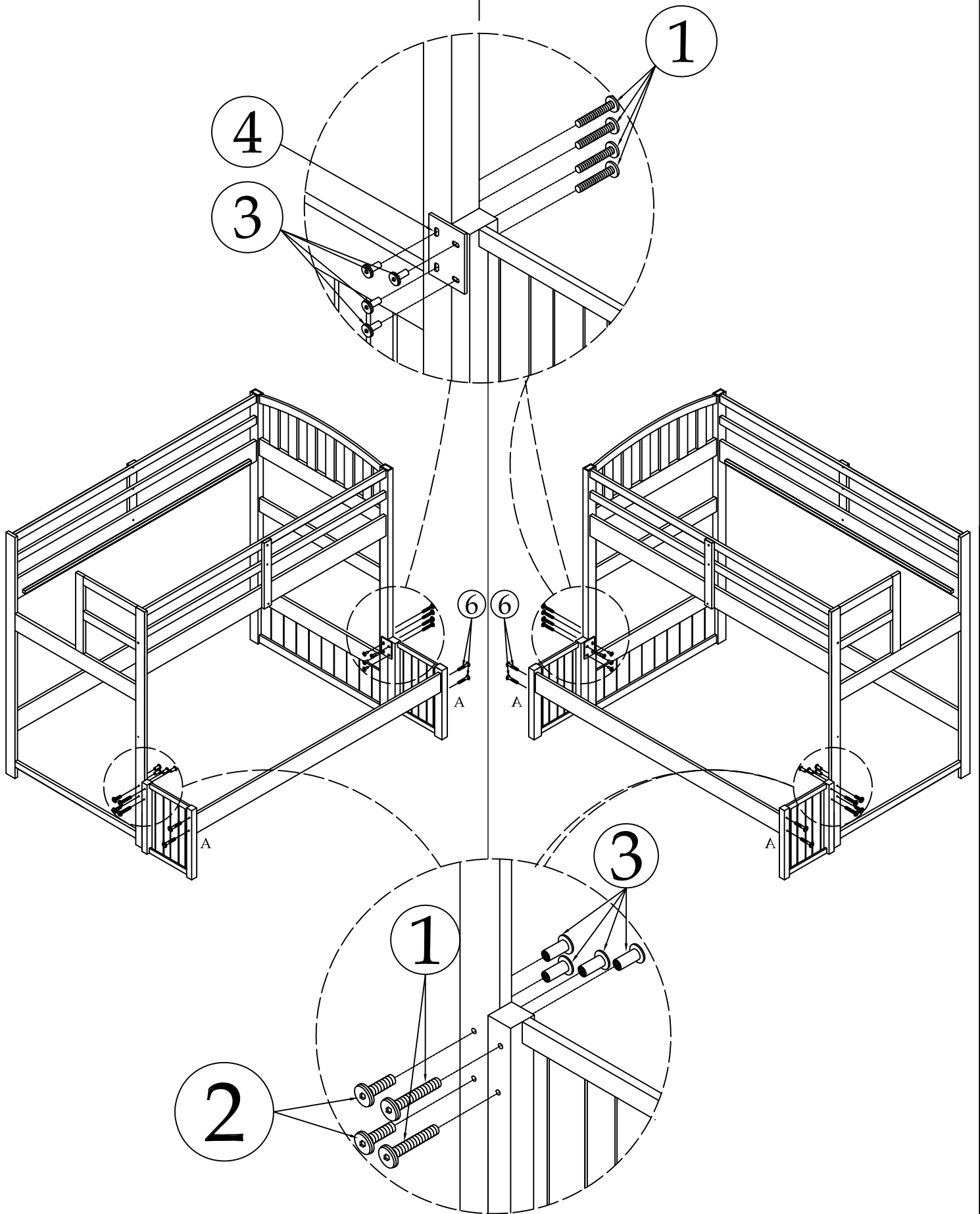

To use give Trundle Bed

5 = 13pcs  
  
 Screw Ø4x30

Center Support Rail for Full Extension Kit has two attachment positions :

- 1) For use with Storage Drawers (Support is in the center of the Slats).
- 2) For use with a Trundle Bed (Support is toward the back end of the Slats).
- 3) Either position can be used if you do not plan to use either a Trundle or Storage Drawers.



1 = 6pcs  Bolt Ø6 x 35mm	2 = 2pcs  Bolt Ø6 x 10mm	3 = 8pcs  Female Half Moon	4 = 2pcs  Metal Plate	6 = 2pcs  Bolt Ø6 x 80mm
---	--	---	--	---

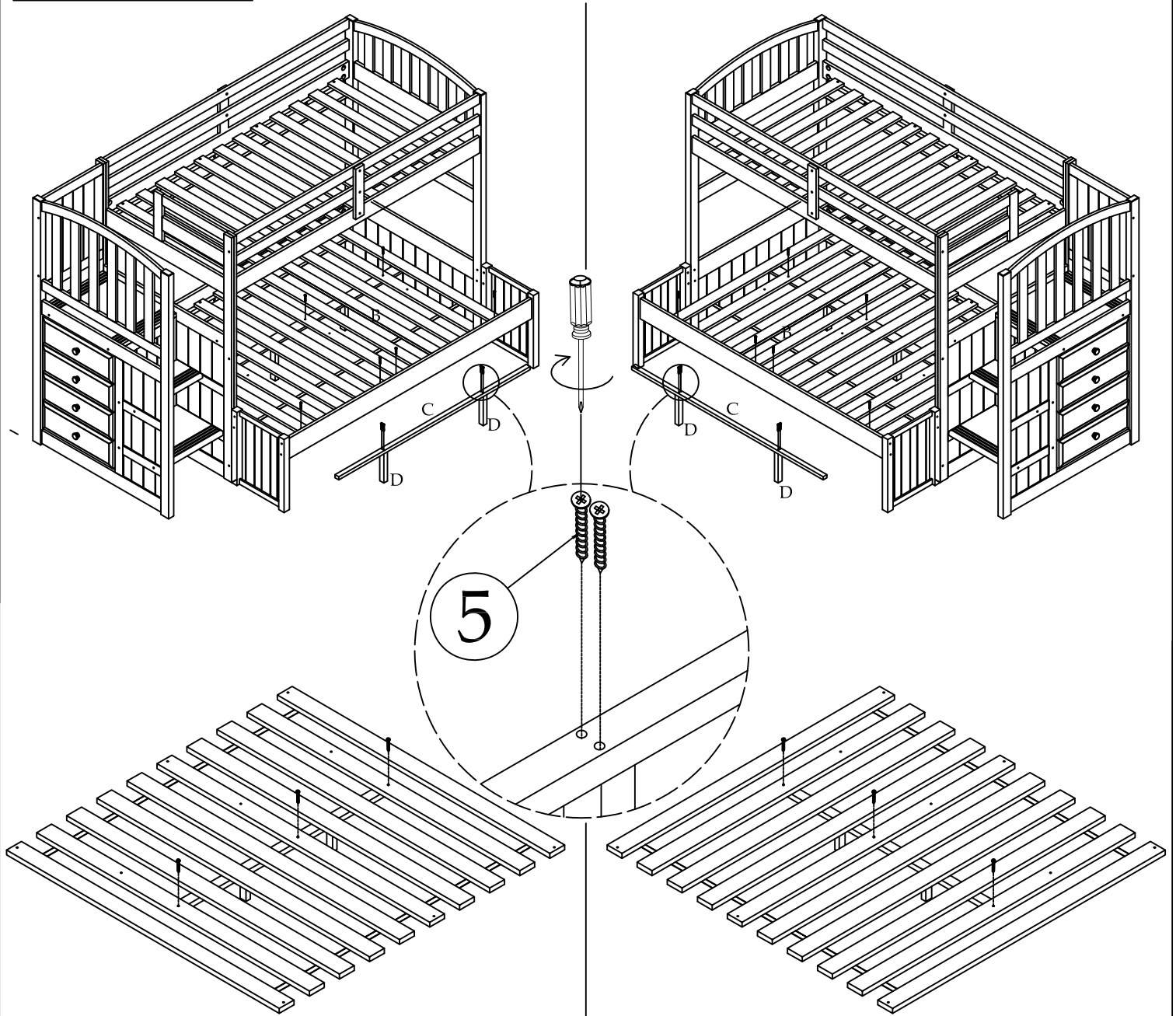

To use give Storage Drawers

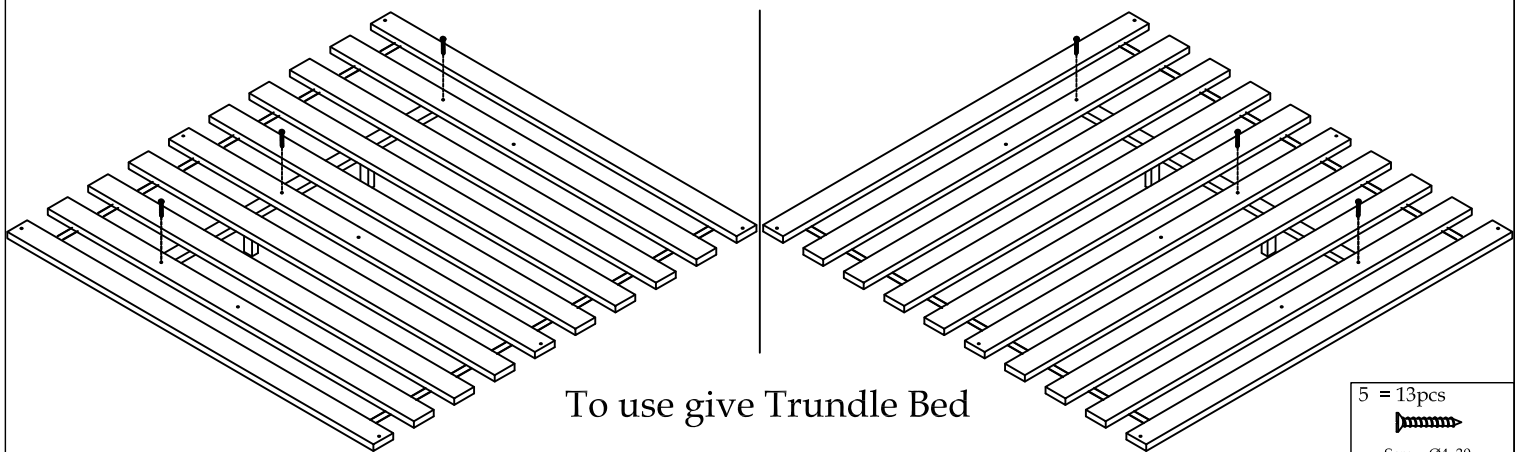

To use give Trundle Bed

5 = 13pcs  
  
 Screw Ø4x30

Center Support Rail for Full Extension Kit has two attachment positions :

- 1) For use with Storage Drawers (Support is in the center of the Slats).
- 2) For use with a Trundle Bed (Support is toward the back end of the Slats).
- 3) Either position can be used if you do not plan to use either a Trundle or Storage Drawers.