

Fort Worth, Texas 76140

ASSEMBLY INSTRUCTIONS

715 MISSION TENT BED

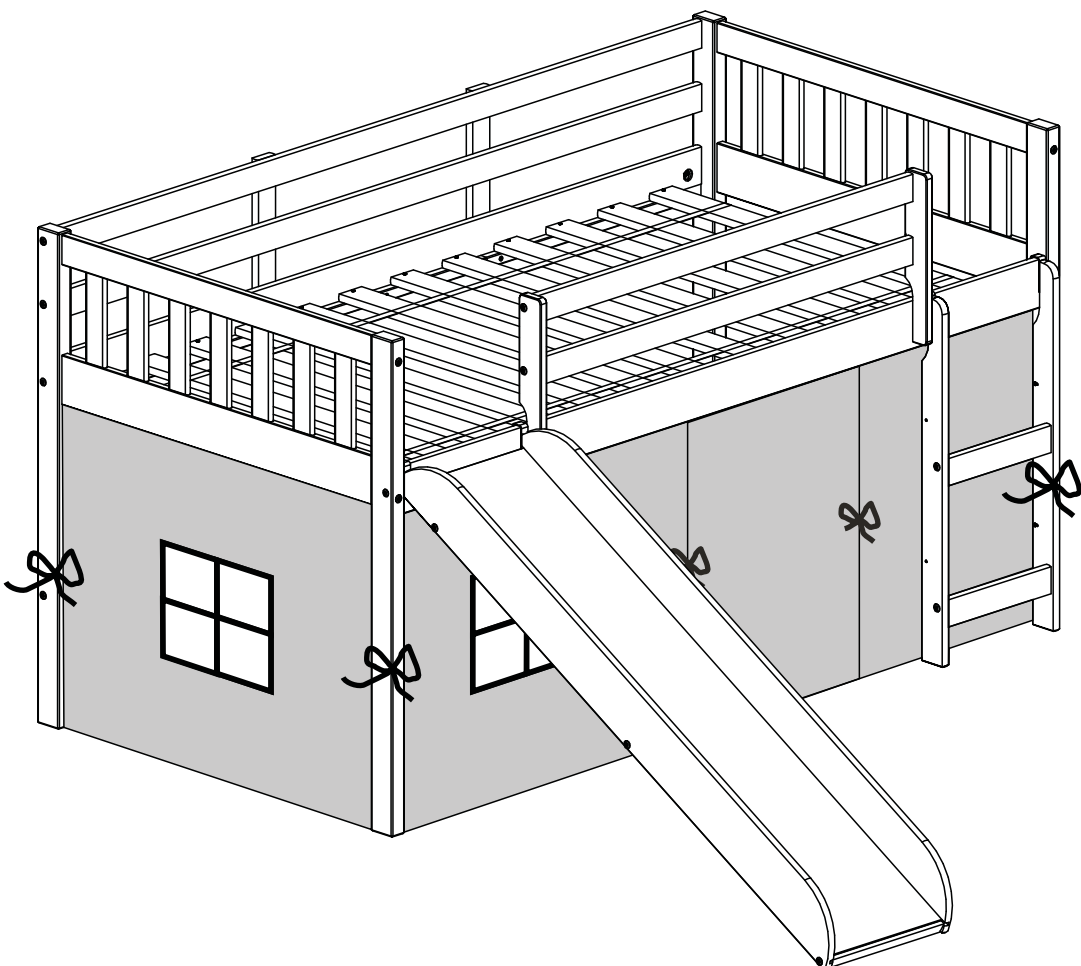

Thank you for purchasing this quality product. Be sure to check all packing material carefully for small parts which may have come loose inside the carton during shipment. Separate, identify and count all parts and hardware.

Compare with the parts list to be sure all parts are present.
"DO NOT TIGHTEN SCREWS UNTIL COMPLETELY ASSEMBLED"

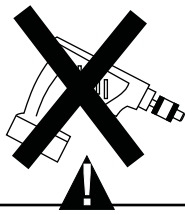

* Use of power tool to assemble this product will invalidate any claim and damage this product making unsafe !!!
* Please assemble on a clean soft surface to avoid damage.

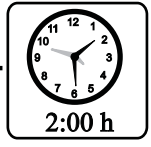

Tools Required

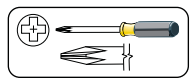

(Not included)

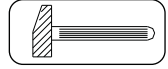

(Not included)

IMPORTANT:

PLEASE READ INSTRUCTIONS BEFORE STARTING THE ASSEMBLY



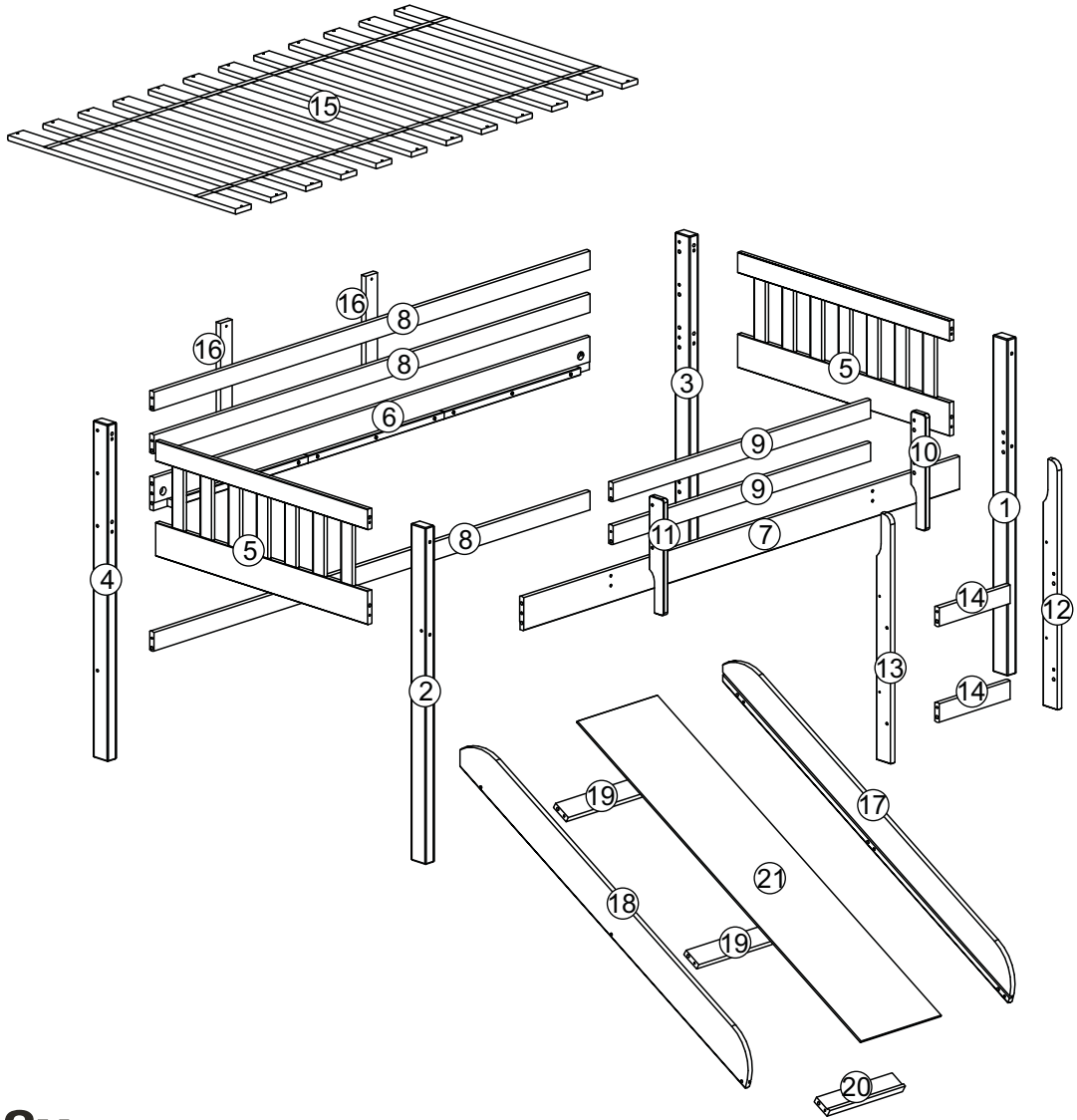



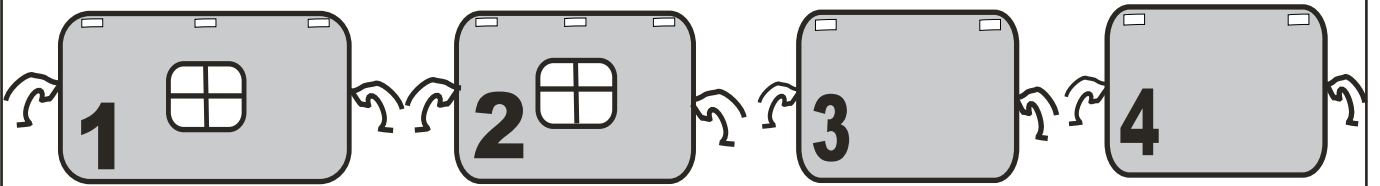

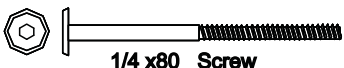

Part List - 715 MISSION TENT BED

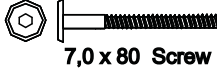
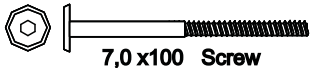

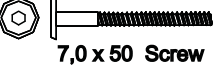
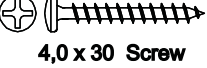
2x



Identifying the Hardware-Identify the hardware using the illustrations below.

A  Qty 04	B  Qty 04	C  Qty 06
D  Qty 08	E  Qty 36	F  Qty 18
G  Qty 30	H  Qty 02	I  Qty 12
J  Qty 04	K  Qty 04	L  Qty 01

01

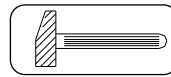
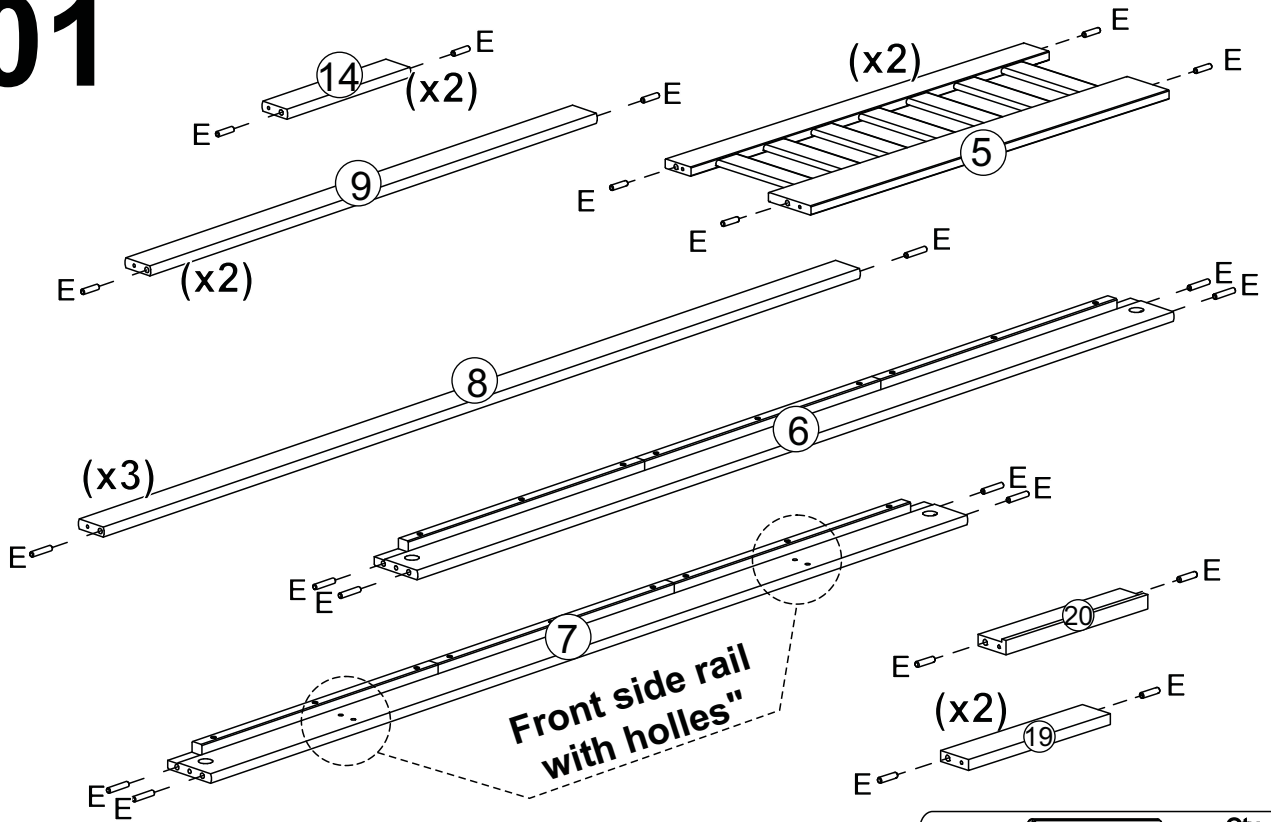

E 10 x 40 Wood Dowel Qty **36**

02

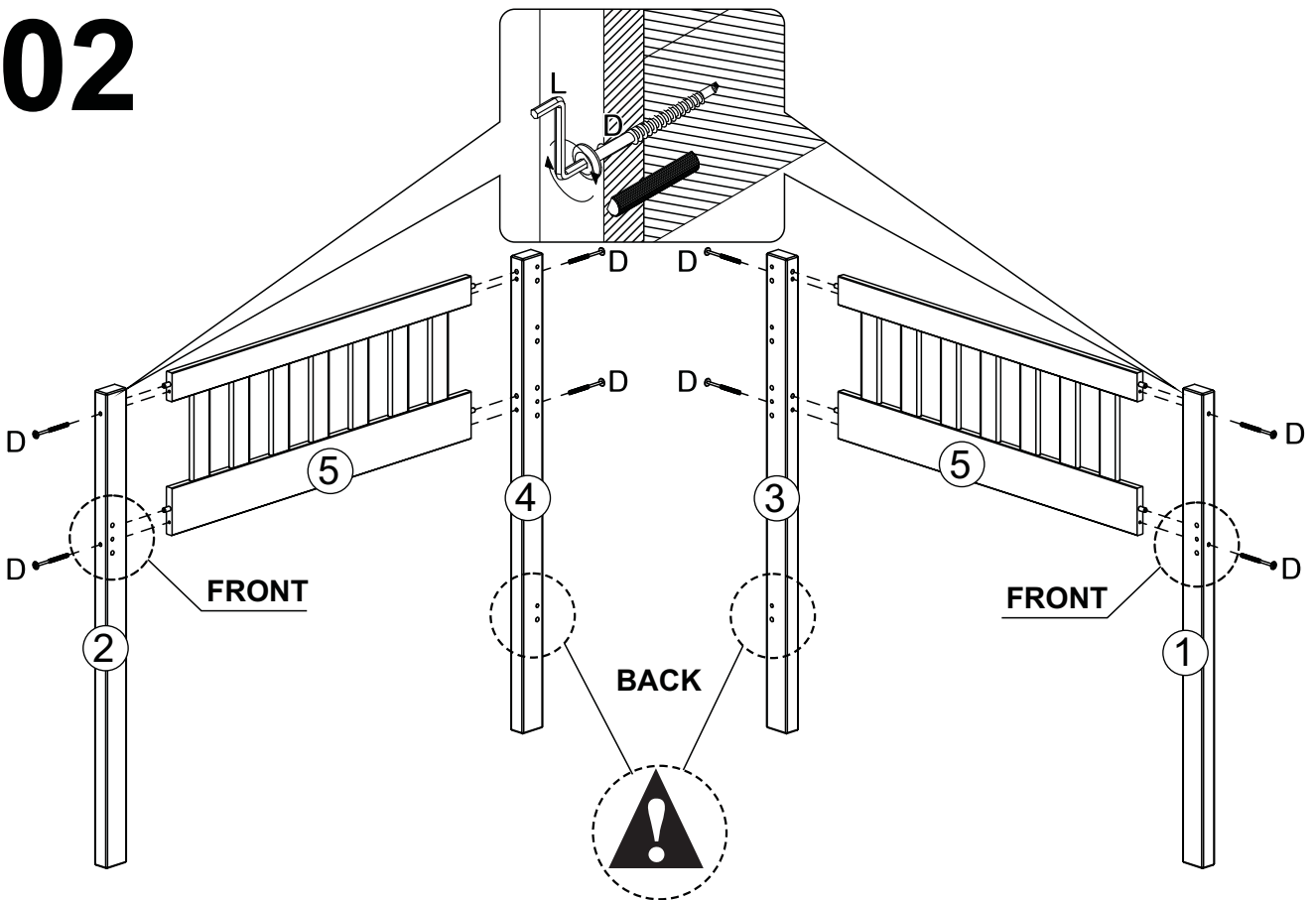

D

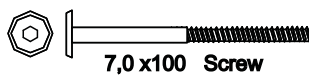

7,0 x 100 Screw

Qty **08**

L



Hex Screwdriver

Qty **01**

03

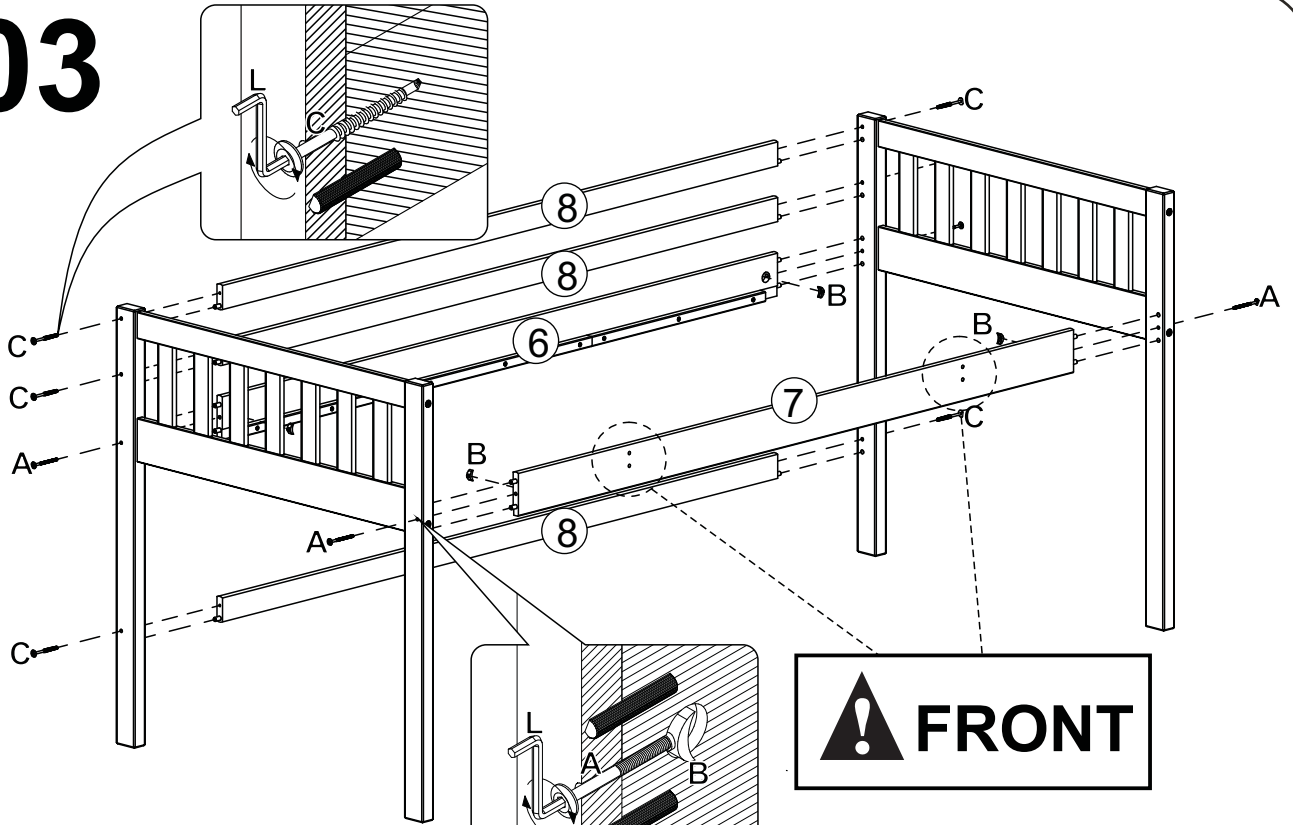

A  Qty **04**
1/4 x 80 Screw

B  Qty **04**
1/4" Half Moon

C  Qty **06**
7,0 x 80 Screw

L  Qty **01**
Hex Screwdriver

04

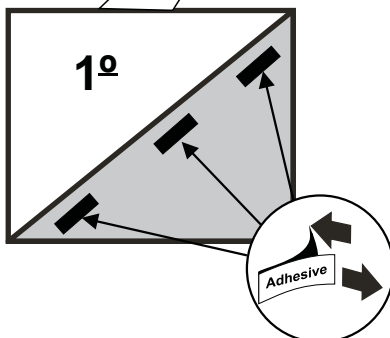
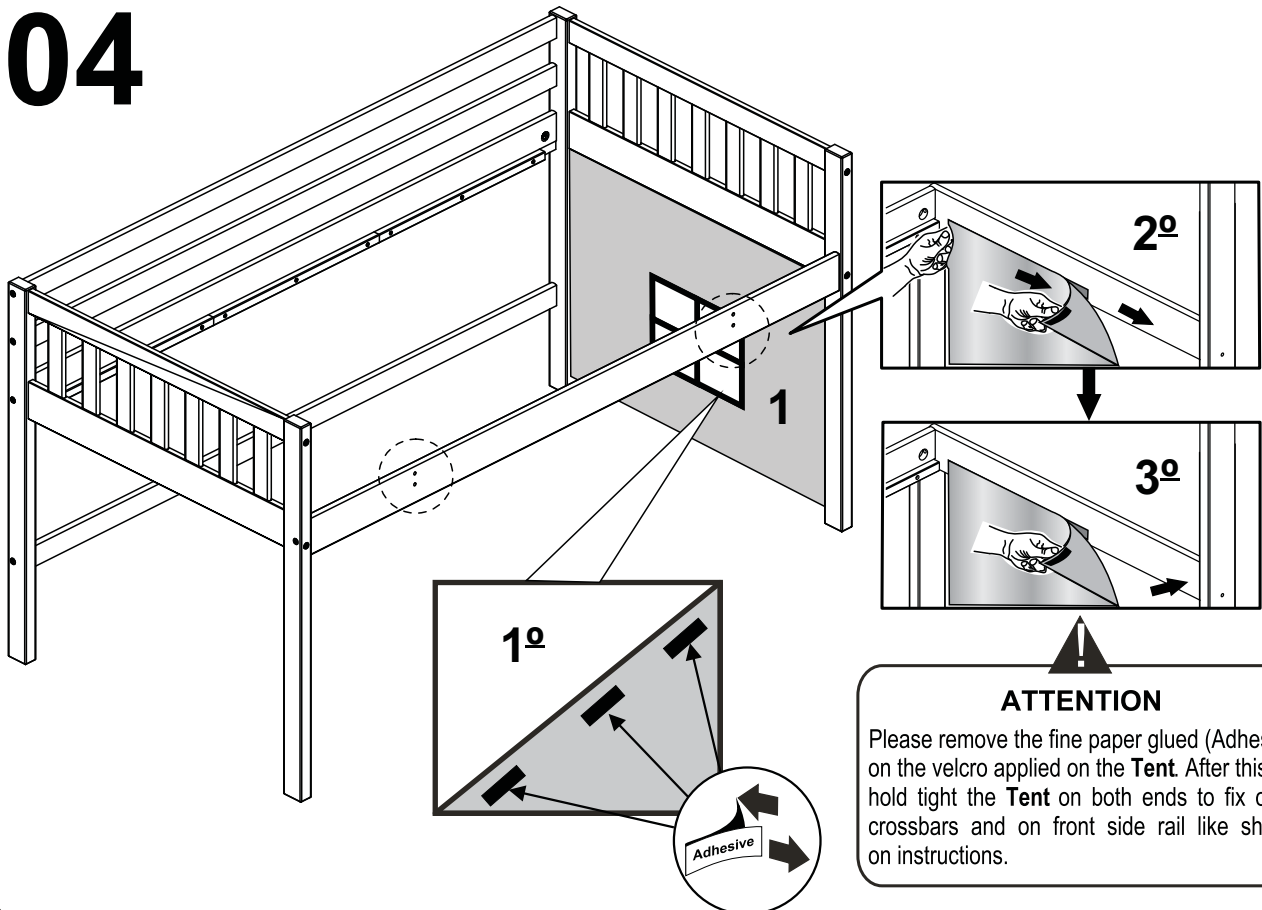

ATTENTION
Please remove the fine paper glued (Adhesed) on the velcro applied on the Tent. After this step, hold tight the Tent on both ends to fix on the crossbars and on front side rail like showing on instructions.

05

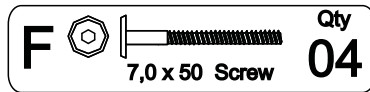
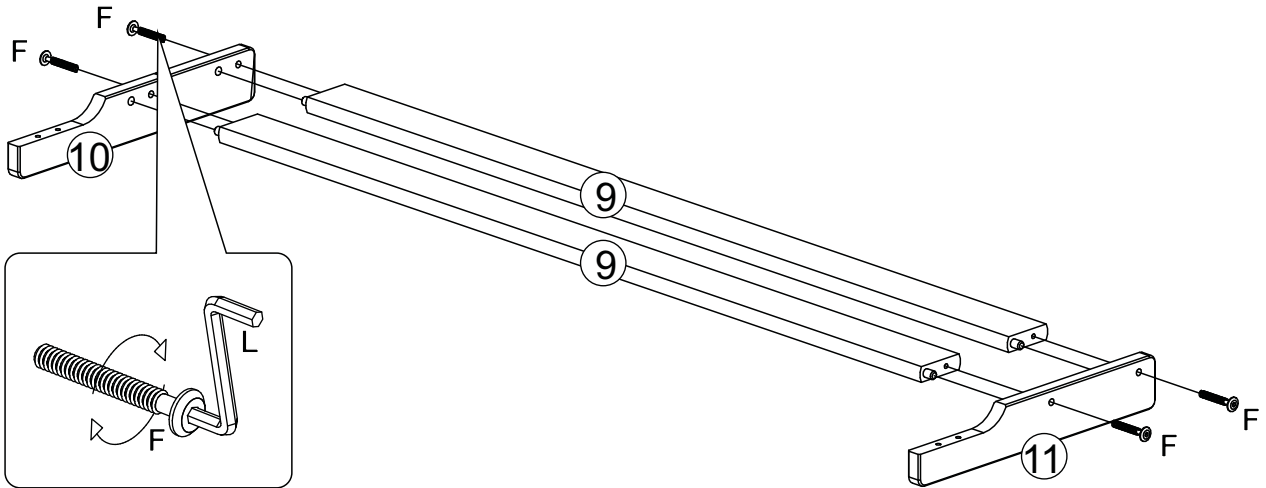

06

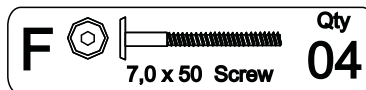
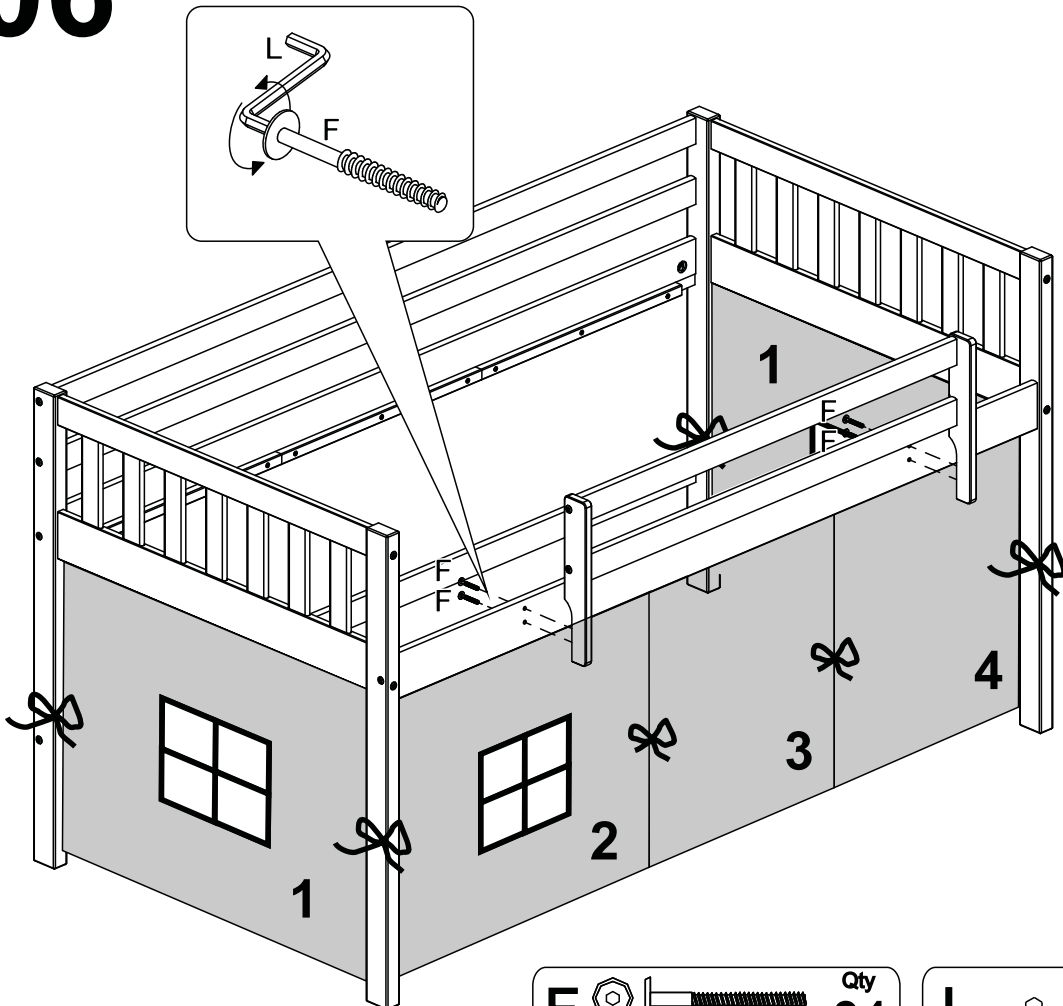

07 LADDER

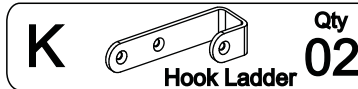
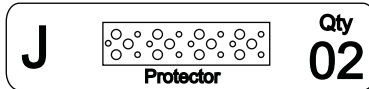
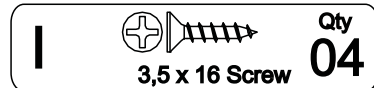
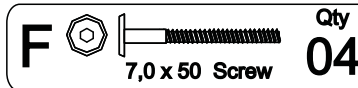
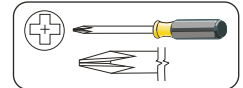
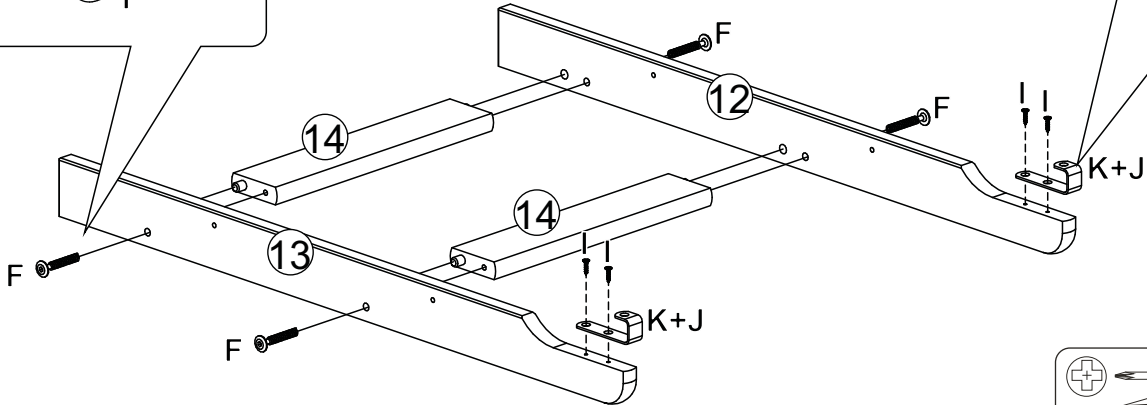
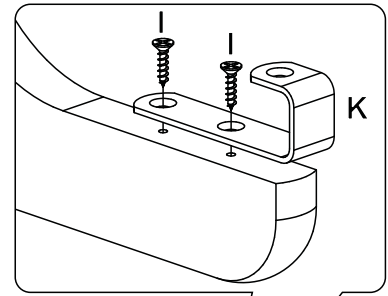
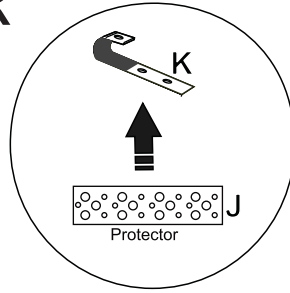
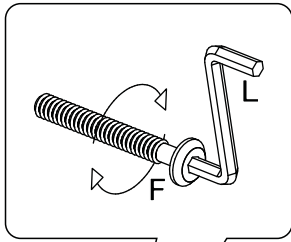

08

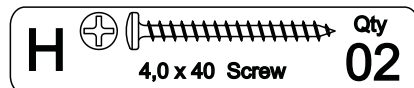
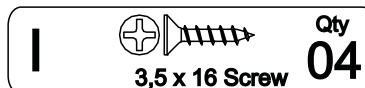
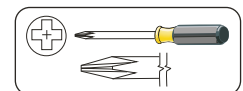
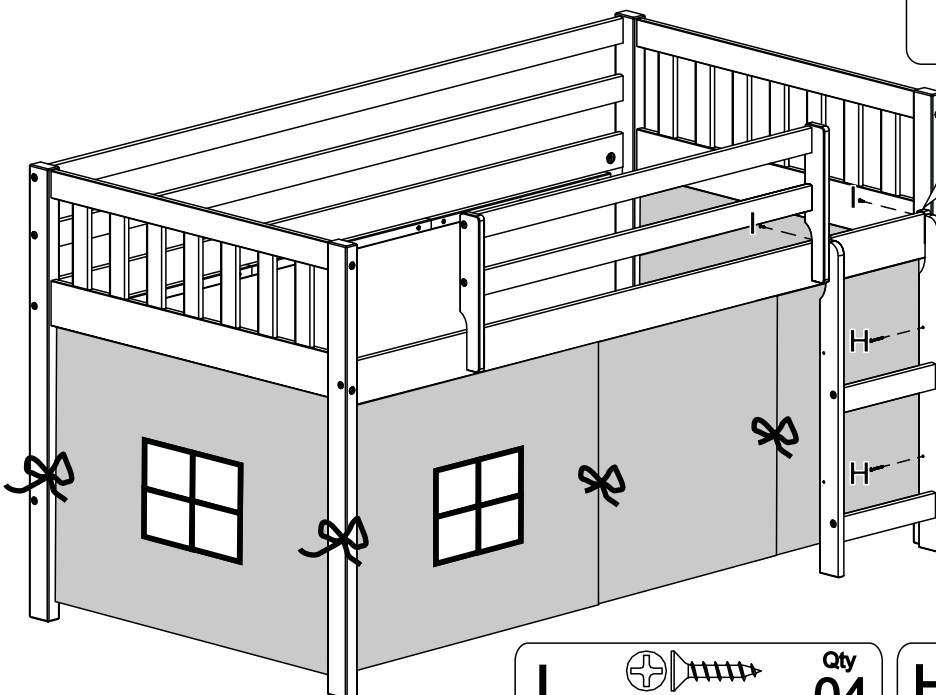
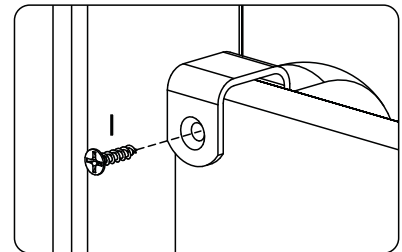

09

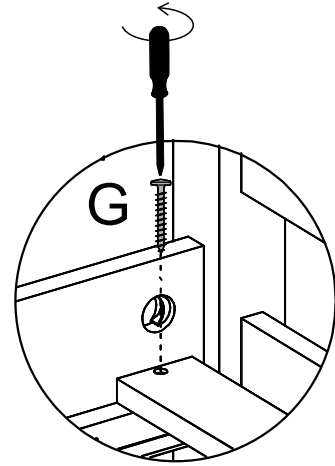
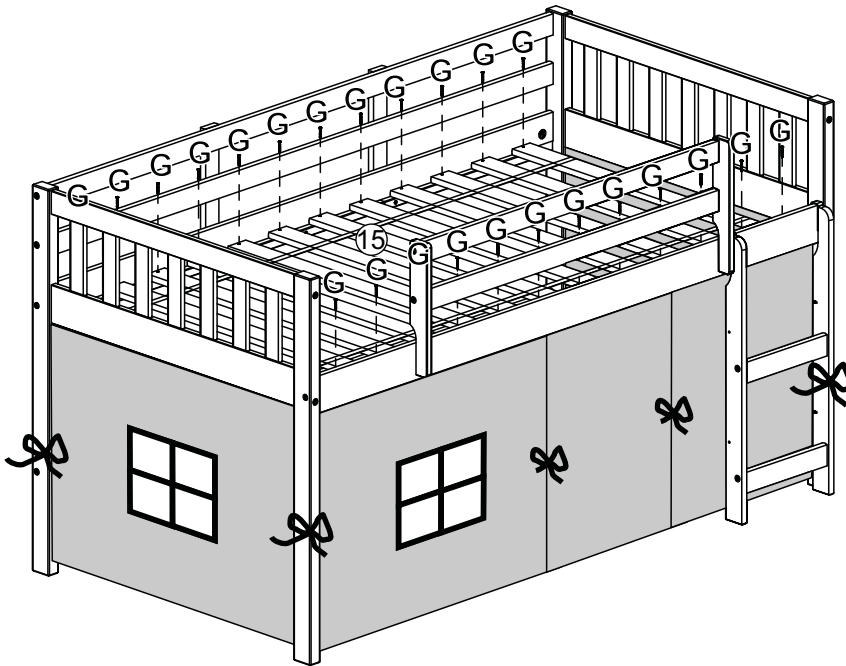

The first slat must be fixed here at 3" from each headboard end.

!
Install slat kit with spacer tape on top (Facing up).

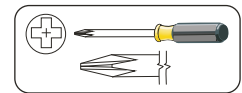

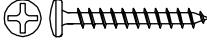

G  Qty 24
4,0 x 30 Screw

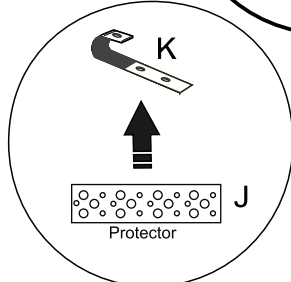
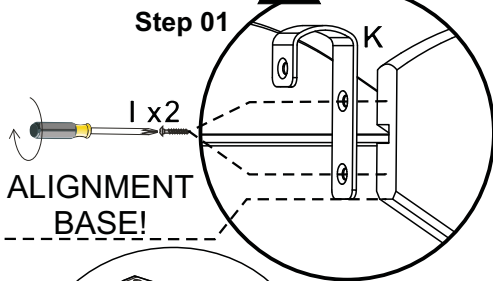
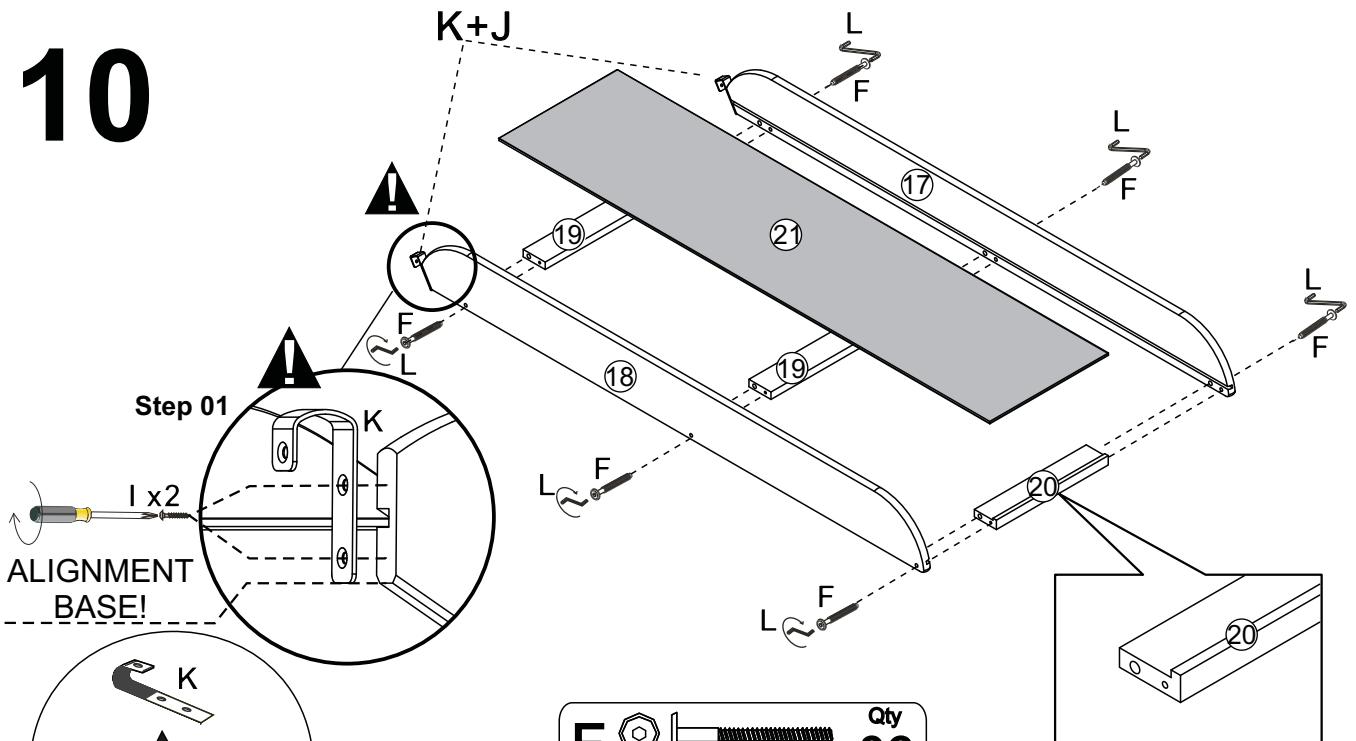
10



F  Qty 06
7,0 x 50 Screw

I  Qty 04
3,5 x 16 Screw

K  Qty 02
Hook Ladder

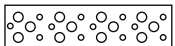
J  Qty 02
Protector

L  Qty 01
Hex Screwdriver

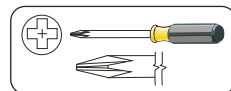

11

WARNING
THE MATTRESS
SURFACE MUST NOT
BE ABOVE THIS LINE
"MATTRESS 8" HIGH LIMITED"

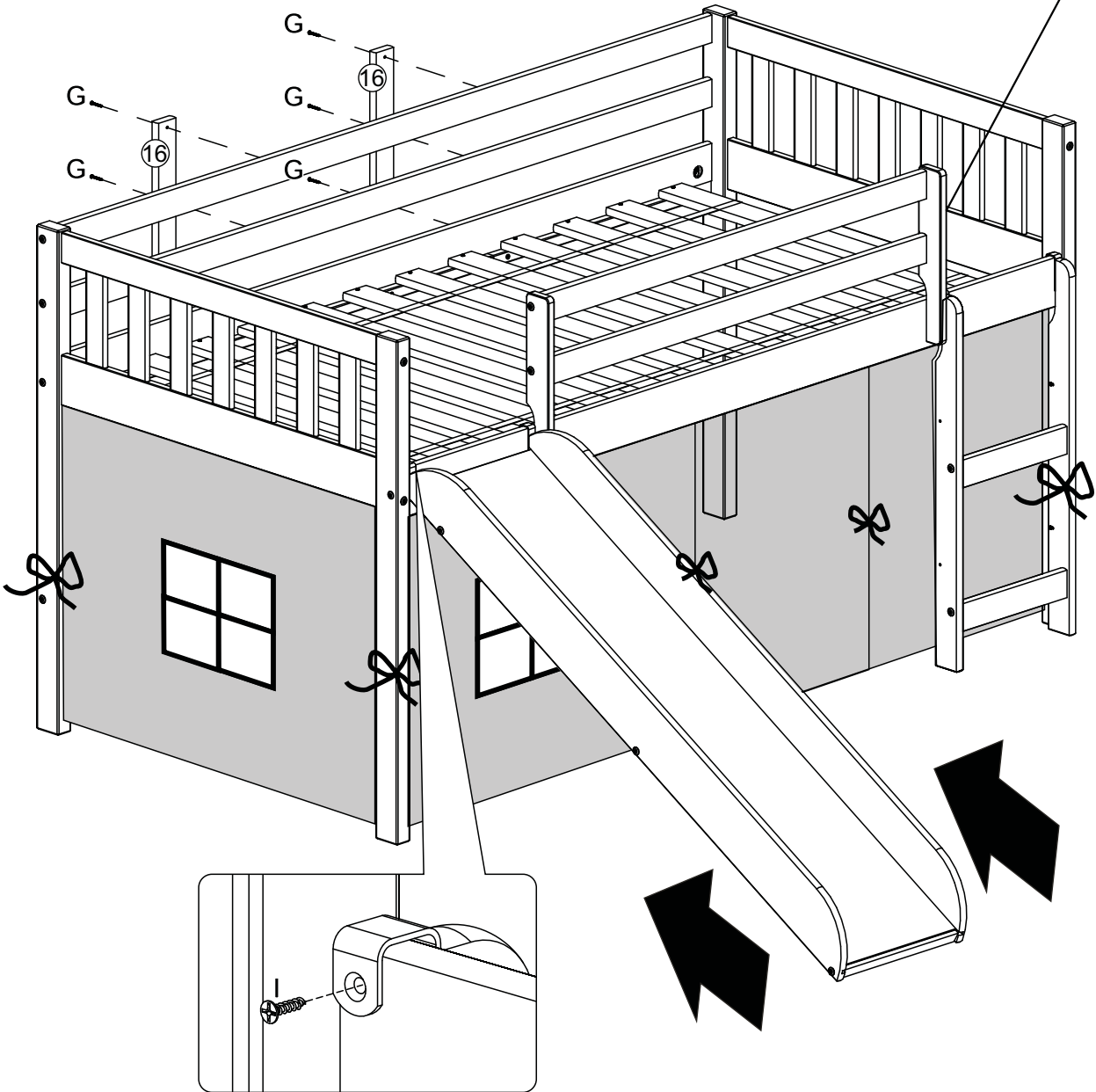

G  4,0 x 30 Screw Qty **06**

I  3,5 x 16 Screw Qty **02**

